

N-CHANNEL ENHANCEMENT MODE POWER MOSFET

MTNN20N03Q8

	N-CH 1	N-CH 2
BV_{DSS}	30V	60V
I_D	8A	0.115A
$R_{DSON(MAX)}$	20mΩ	5Ω

Description

The MTNN20N03Q8 provides the designer with the best combination of fast switching, ruggedized device design, low on-resistance and cost effectiveness.

The SOP-8 package is universally preferred for all commercial-industrial surface mount applications and suited for low voltage applications such as DC/DC converters.

Features

- Simple drive requirement
- Low on-resistance
- Fast switching speed
- Two N-ch MOSFETs in a package
- Pb-free lead plating package

Equivalent Circuit

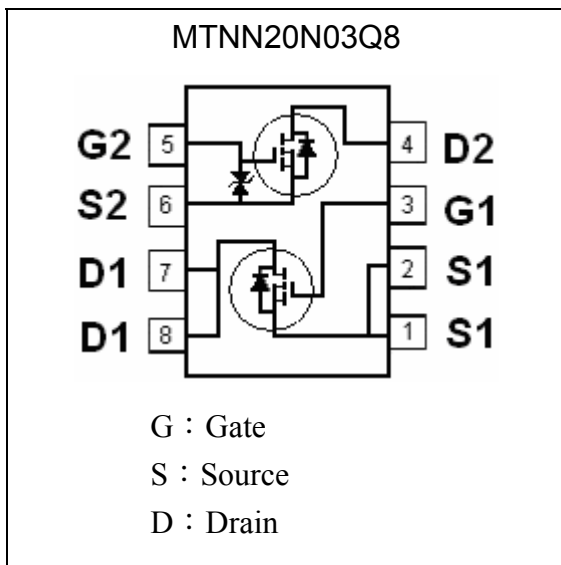

Outline

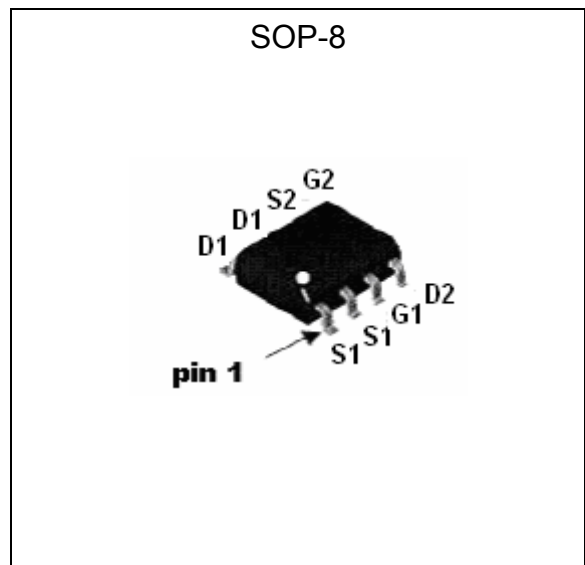



Absolute Maximum Ratings (Ta=25°C)

Parameter	Symbol	Limits		Unit
		N-CH 1	N-CH 2	
Drain-Source Voltage	V _{DS}	30	60	V
Gate-Source Voltage	V _{GS}	±20	±20	V
Continuous Drain Current @ T _C =25 °C (Note 1)	I _D	8	0.115	A
Continuous Drain Current @ T _C =100 °C (Note 1)	I _D	6	0.08	A
Pulsed Drain Current (Note 2&3)	I _{DM}	32	0.7	A
Total Power Dissipation @ T _A =25 °C Linear Derating Factor	P _d	2	0.4	W
		0.016	0.016	W / °C
ESD susceptibility (Note 4)			1250	V
Operating Junction Temperature	T _j	-55~+150		°C
Storage Temperature	T _{stg}	-55~+150		°C
Thermal Resistance, Junction-to-Ambient (Note 1)	R _{th,ja}	62.5		°C/W

- Note : 1. Surface mounted on 1 in² copper pad of FR-4 board; 135°C/W when mounted on minimum copper pad.
 2. Pulse width limited by maximum junction temperature.
 3. Pulse width ≤ 300µs, duty cycle ≤ 2%.
 4. Human body model, 1.5kΩ in series with 100pF

Characteristics (Tj=25°C, unless otherwise specified)

N-Channel MOSFET 1

Symbol	Min.	Typ.	Max.	Unit	Test Conditions
Static					
B _V D _{SS}	30	-	-	V	V _{GS} =0, I _D =250µA
V _{GS(th)}	1.0	1.5	3.0	V	V _{DS} = V _{GS} , I _D =250µA
G _{FS}	-	16	-	S	V _{DS} =5V, I _D =8A
I _{GSS}	-	-	±100	nA	V _{GS} =±20
I _{DSS}	-	-	1	µA	V _{DS} =24V, V _{GS} =0
	-	-	25		V _{DS} =20V, V _{GS} =0, T _j =125°C
*R _{DS(ON)}	-	15.5	20	mΩ	V _{GS} =10V, I _D =8A
	-	23	31		V _{GS} =5V, I _D =6A
Dynamic					
*Q _g (V _{GS} =10V)	-	11	-	nC	I _D =8A, V _{DS} =15V, V _{GS} =10V
*Q _g (V _{GS} =5V)	-	6	-		
*Q _{gs}	-	1.2	-		
*Q _{gd}	-	3.3	-		
*t _{d(ON)}	-	11	-	ns	V _{DS} =15V, I _D =1A, V _{GS} =10V, R _G =6Ω
*t _r	-	16	-		
*t _{d(OFF)}	-	36	-		
*t _f	-	20	-		
C _{iss}	-	1115	-	pF	V _{GS} =0V, V _{DS} =15V, f=1MHz
C _{oss}	-	116	-		
C _{rss}	-	82	-		
R _g	-	2	-		



Source-Drain Diode					
*I _S	-	-	2.3	A	
*I _{SM}	-	-	9.2		
*V _{SD}	-	-	1.2	V	I _F =I _S , V _{GS} =0V
*t _{rr}	-	50	-	ns	I _F =I _S , V _{GS} =0, dI/dt=100A/μs
*Q _{rr}	-	2	-	nC	

N-Channel MOSFET 2

Symbol	Min.	Typ.	Max.	Unit	Test Conditions
BV _{DSS} *	60	-	-	V	V _{GS} =0, I _D =10μA
V _{GS(th)}	1	-	2.5	V	V _{DS} =V _{GS} , I _D =250μA
I _{GSS}	-	-	±10	μA	V _{GS} =±20V, V _{DS} =0
I _{DSS}	-	-	1	μA	V _{DS} =60V, V _{GS} =0
R _{DS(ON)} *	-	3.6	5.5	Ω	I _D =100mA, V _{GS} =5V
	-	3	5		I _D =100mA, V _{GS} =10V
G _{FS}	100	-	-	mS	V _{DS} =10V, I _D =100mA
C _{iss}	-	30.5	-	pF	V _{DS} =10V, V _{GS} =0, f=1MHz
C _{oss}	-	9.3	-		
C _{rss}	-	5.9	-		

*Pulse Test : Pulse Width ≤300μs, Duty Cycle ≤2%

Ordering Information

Device	Package	Shipping
MTNN20N03Q8	SOP-8 (Pb-free lead plating package)	3000 pcs / Tape & Reel

**Typical Characteristics
N-CH MOSFET 1**

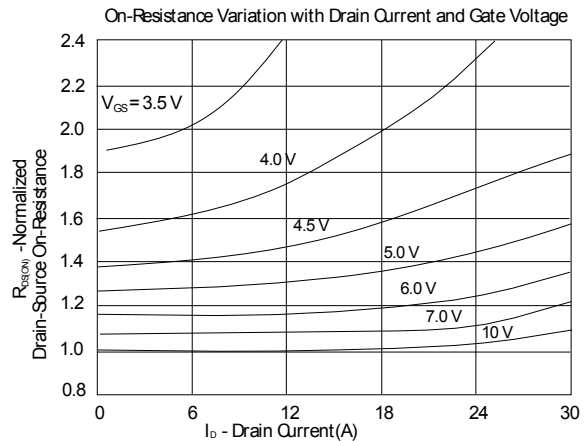
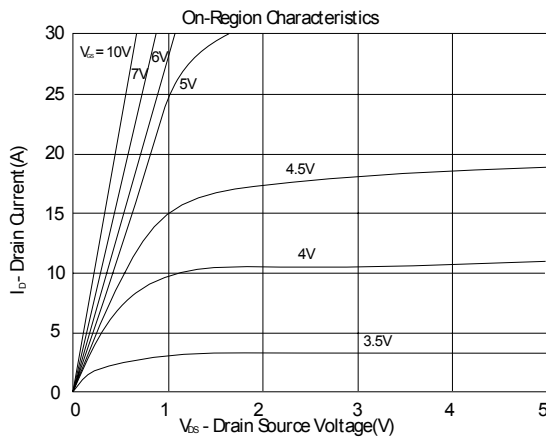

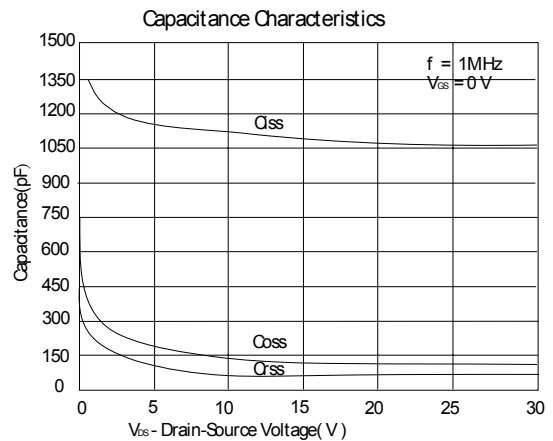
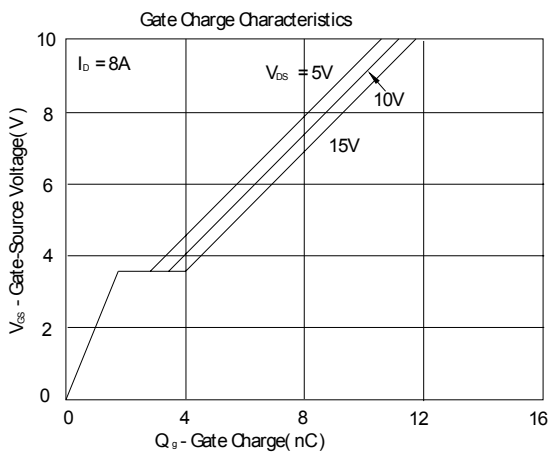
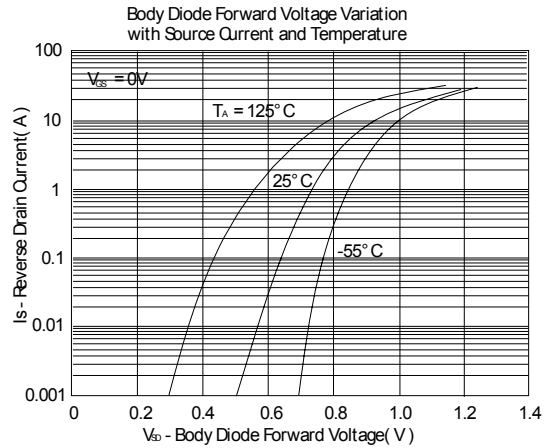
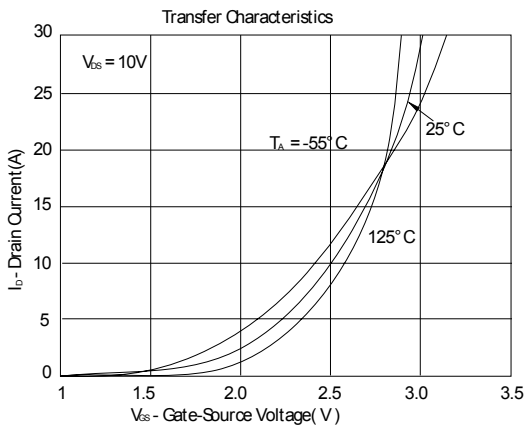
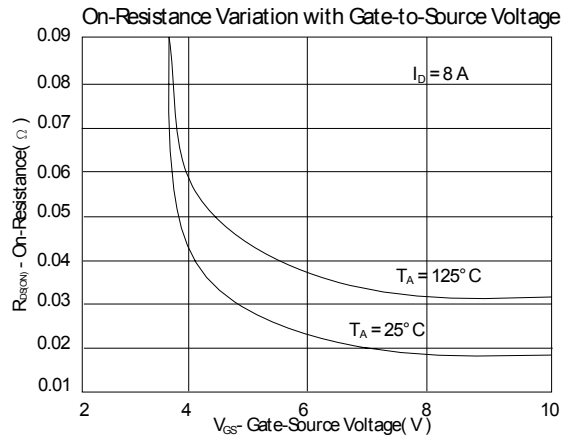
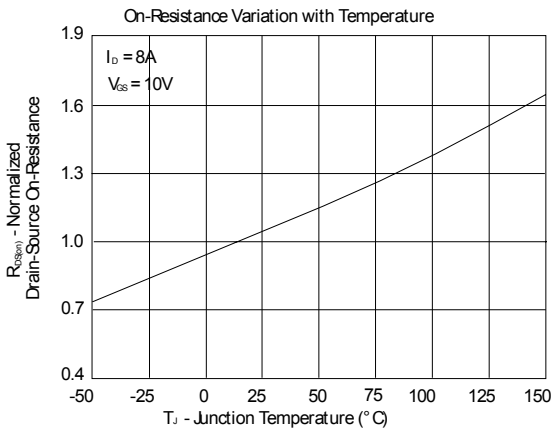

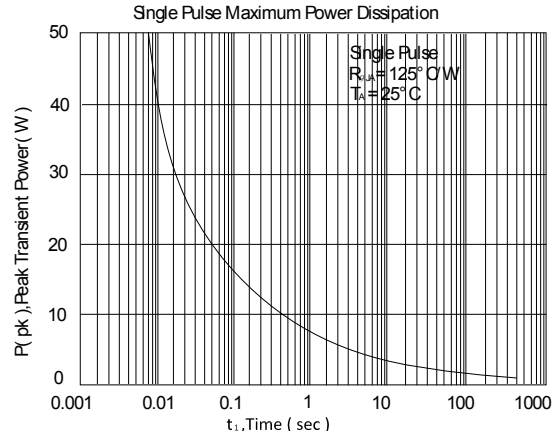
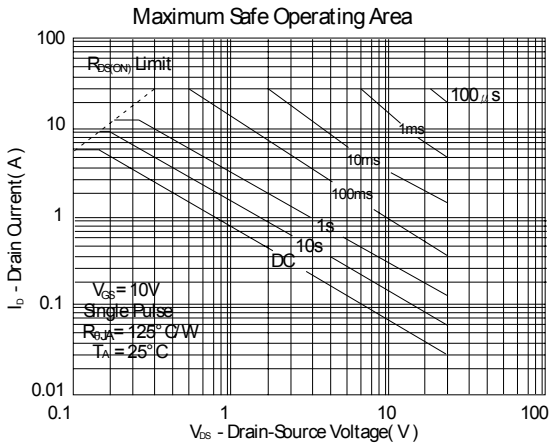

N-CH MOSFET 2

Typical Output Characteristics

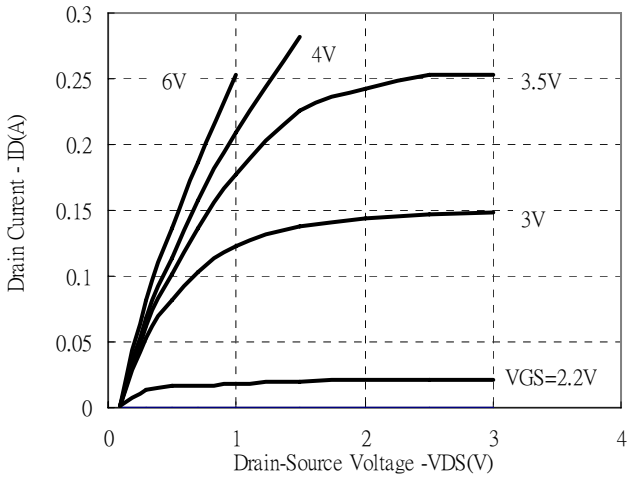

Typical Transfer Characteristics

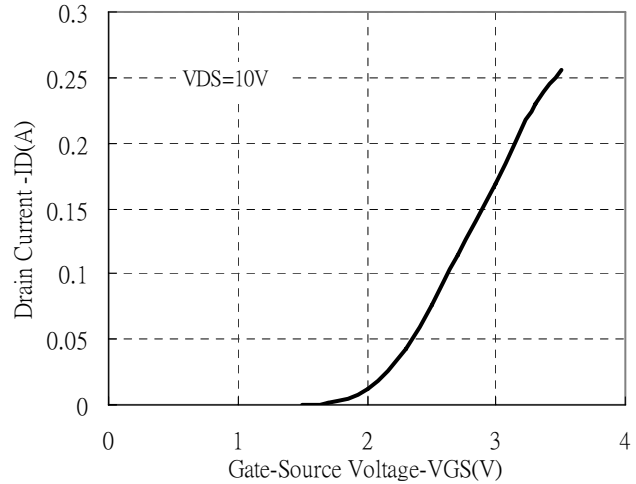

Static Drain-Source On-State resistance vs Drain Current

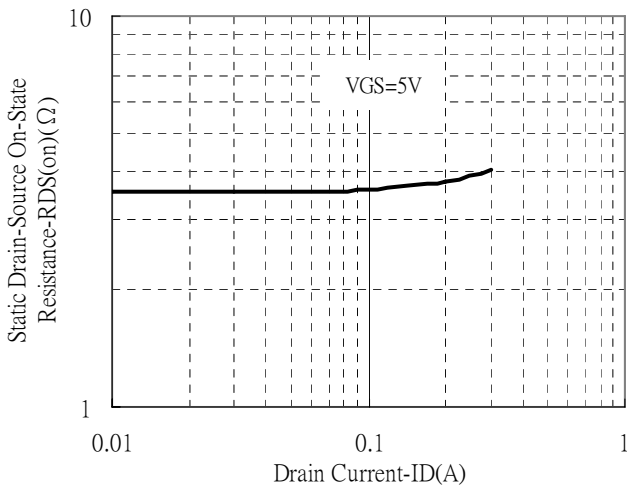

Static Drain-Source On-State resistance vs Drain Current

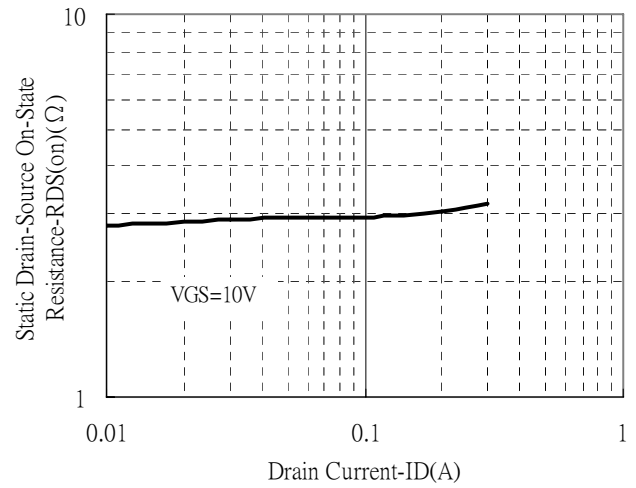



Static Drain-Source On-State Resistance vs Gate-Source Voltage

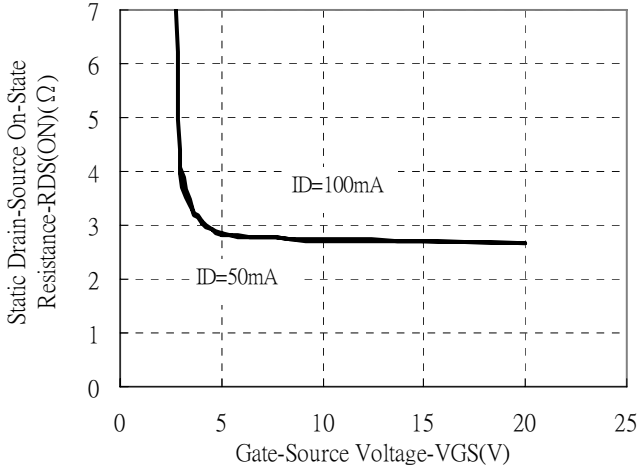

Reverse Drain Current vs Source-Drain Voltage

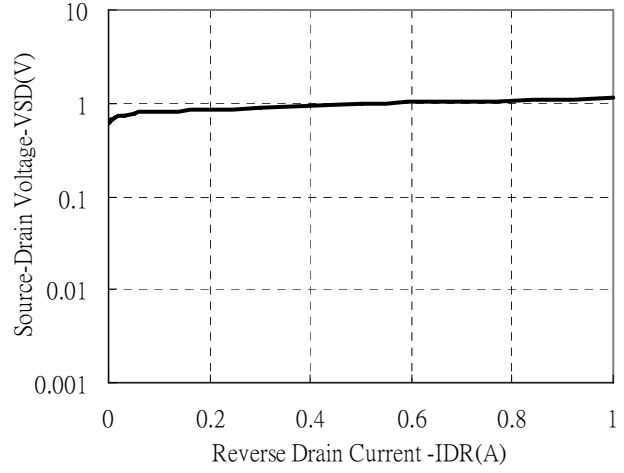

Capacitance vs Drain-to-Source Voltage

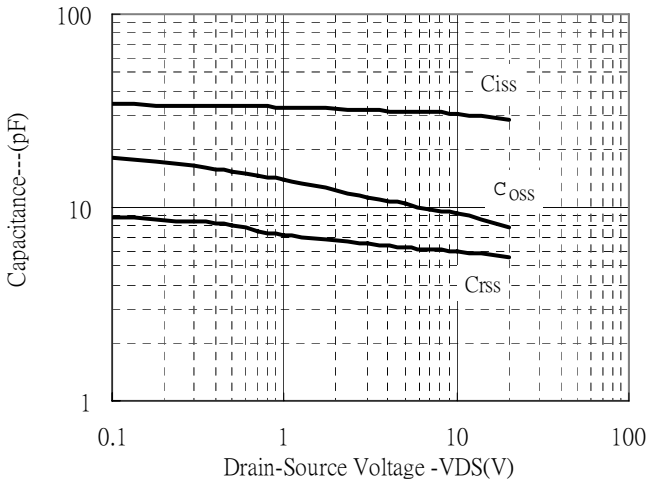

Reel Dimension

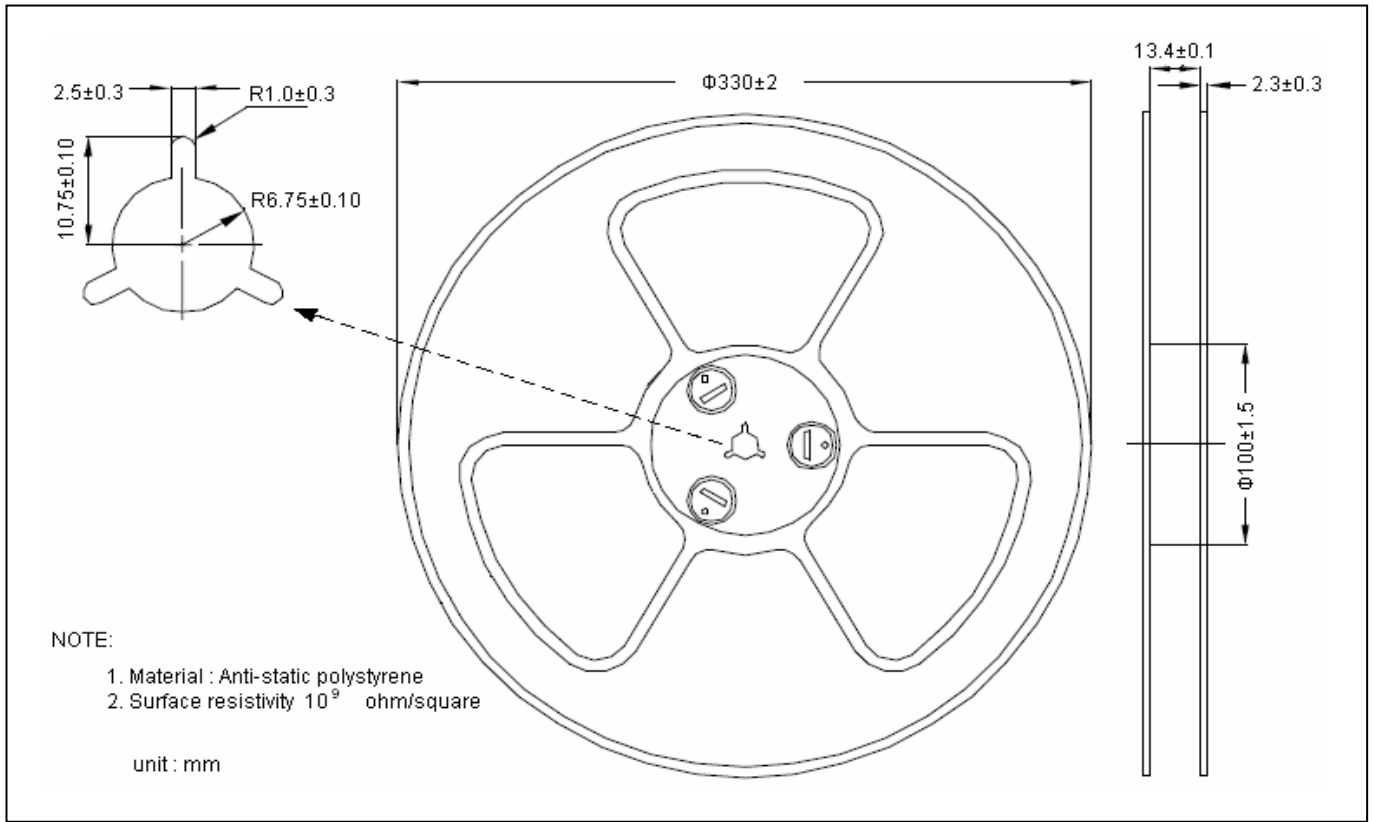

Carrier Tape Dimension

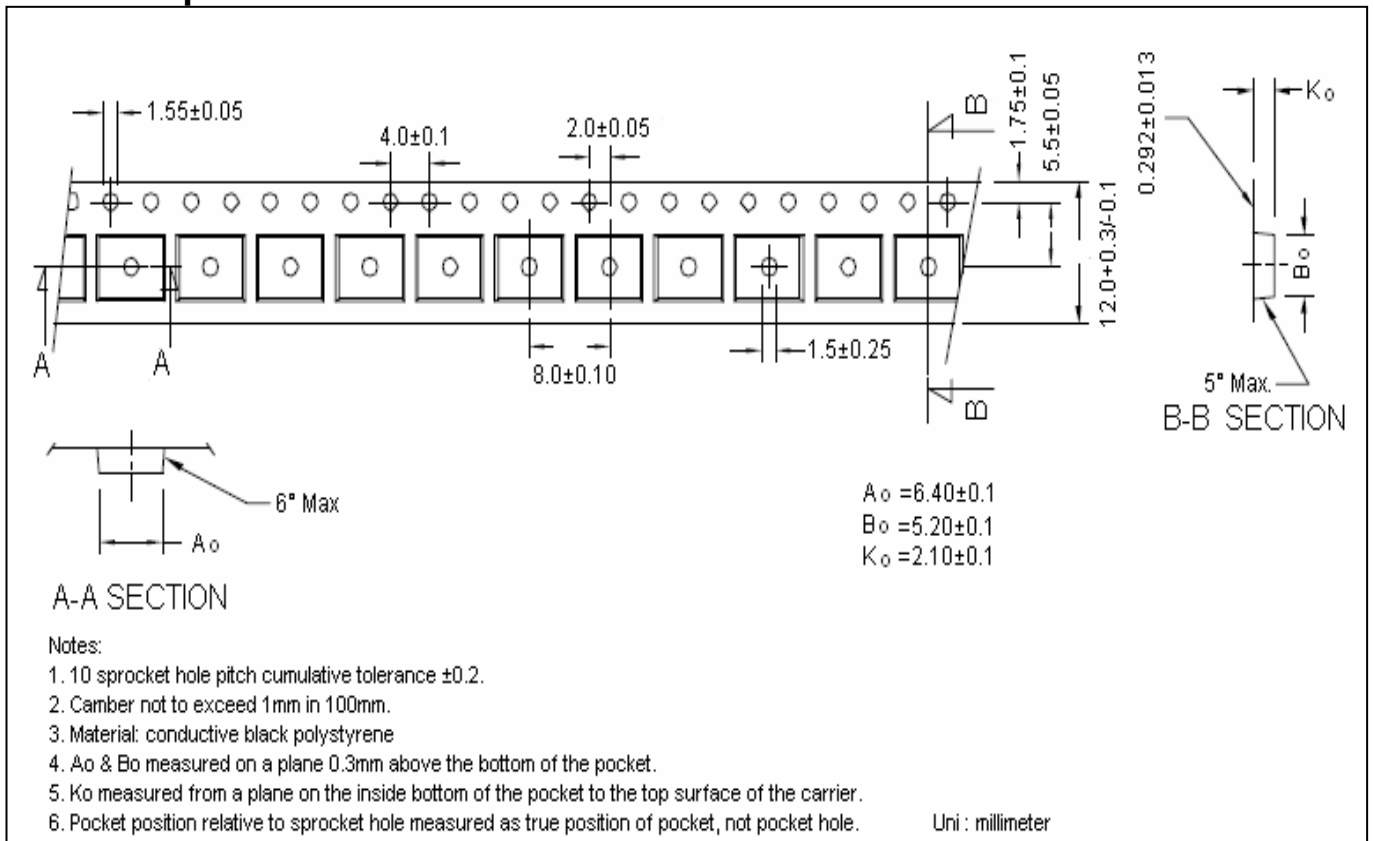

Recommended wave soldering condition

Product	Peak Temperature	Soldering Time
Pb-free devices	260 +0/-5 °C	5 +1/-1 seconds

Recommended temperature profile for IR reflow

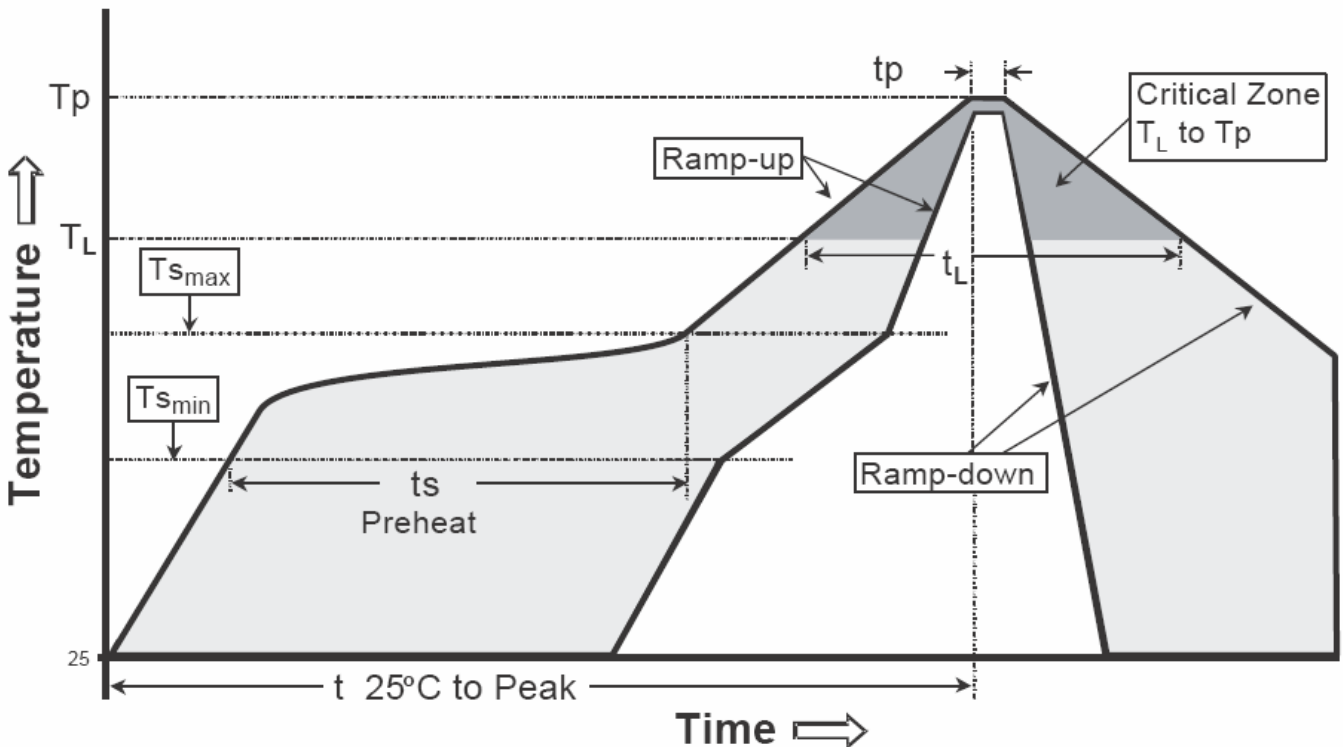

Profile feature	Sn-Pb eutectic Assembly	Pb-free Assembly
Average ramp-up rate (Tsmax to Tp)	3°C/second max.	3°C/second max.
Preheat		
-Temperature Min(Ts min)	100°C	150°C
-Temperature Max(Ts max)	150°C	200°C
-Time(ts min to ts max)	60-120 seconds	60-180 seconds
Time maintained above:		
-Temperature (TL)	183°C	217°C
- Time (tl)	60-150 seconds	60-150 seconds
Peak Temperature(Tp)	240 +0/-5 °C	260 +0/-5 °C
Time within 5°C of actual peak temperature(tp)	10-30 seconds	20-40 seconds
Ramp down rate	6°C/second max.	6°C/second max.
Time 25 °C to peak temperature	6 minutes max.	8 minutes max.

Note : All temperatures refer to topside of the package, measured on the package body surface.

SOP-8 Dimension

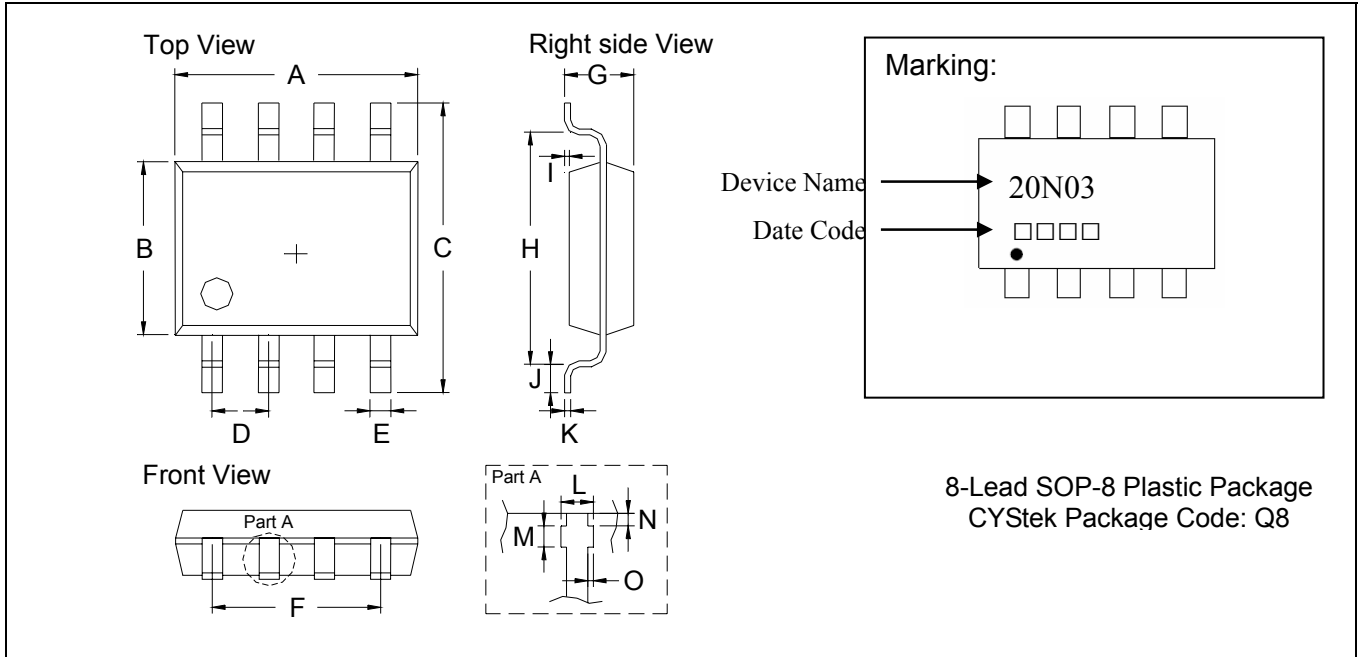

*: Typical

DIM	Inches		Millimeters		DIM	Inches		Millimeters	
	Min.	Max.	Min.	Max.		Min.	Max.	Min.	Max.
A	0.1890	0.2007	4.80	5.10	I	0.0098	REF	0.25	REF
B	0.1496	0.1654	3.80	4.20	J	0.0118	0.0354	0.30	0.90
C	0.2283	0.2441	5.80	6.20	K	0.0074	0.0098	0.19	0.25
D	0.0480	0.0519	1.22	1.32	L	0.0145	0.0204	0.37	0.52
E	0.0138	0.0193	0.35	0.49	M	0.0118	0.0197	0.30	0.50
F	0.1472	0.1527	3.74	3.88	N	0.0031	0.0051	0.08	0.13
G	0.0531	0.0689	1.35	1.75	O	0.0000	0.0059	0.00	0.15
H	0.1889	0.2007	4.80	5.10					

- Notes: 1. Controlling dimension: millimeters.
 2. Maximum lead thickness includes lead finish thickness, and minimum lead thickness is the minimum thickness of base material.
 3. If there is any question with packing specification or packing method, please contact your local CYStek sales office.

Material:

- Lead: Pure tin plated.
- Mold Compound: Epoxy resin family, flammability solid burning class: UL94V-0.

Important Notice:

- All rights are reserved. Reproduction in whole or in part is prohibited without the prior written approval of CYStek.
- CYStek reserves the right to make changes to its products without notice.
- CYStek **semiconductor products are not warranted to be suitable for use in Life-Support Applications, or systems.**
- CYStek assumes no liability for any consequence of customer product design, infringement of patents, or application assistance.