

---

## Keyboard and Embedded Controller for Notebook PC

---

### Product Features

- ARM<sup>®</sup> Cortex<sup>®</sup>-M4 Processor Core
  - 32-Bit ARM v7-M Instruction Set Architecture
  - Hardware Floating Point Unit (FPU)
  - Single 4GByte Addressing Space (Von Neumann Model)
  - Little-Endian Byte Ordering
  - Bit-Banding Feature Included
  - NVIC Nested Vectored Interrupt Controller
    - Up to 240 Individually-Vectored Interrupt Sources Supported
    - 8 Levels of Priority, Individually Assignable By Vector
    - Chip-Level Interrupt Aggregator supported, to expand number of interrupt sources or reduce number of vectors
  - System Tick Timer
  - Complete ARM-Standard Debug Support
    - JTAG-Based DAP Port, Comprised of SWJ-DP and AHB-AP Debugger Access Functions
    - Full DWT Hardware Functionality: 4 Data Watchpoints and Execution Monitoring
    - Full FPB Hardware Breakpoint Functionality: 6 Execution Breakpoints and 2 Literal (Data) Breakpoints
  - Comprehensive ARM-Standard Trace Support
    - Full DWT Hardware Trace Functionality for Watchpoint and Performance Monitoring
    - Full ITM Hardware Trace Functionality for Instrumented Firmware Support and Profiling
    - Full ETM Hardware Trace Functionality for Instruction Trace
    - Full TPIU Functionality for Trace Output Communication
- 128K SRAM (Code or Data)
  - 96K Optimized for Code
  - 32K Optimized for Data
- LPC Interface
  - Supports LPC Bus frequencies of 19MHz to 33MHz
  - LPC I/O Cycles Decoded
  - LPC Memory Cycles Decoded
  - Clock Run Support
  - Serial IRQ
  - ACPI SCI interface
  - SMI# output
- Two SPI Memory Interfaces
  - 3-pin Full Duplex serial communication interface
  - Two Private and Two Shared Chip Selects
  - DMA Support
- 8042 Style Host Interface
  - Mailbox Registers Interface
    - Forty-three 8-Bit scratch registers
    - Two Register Mailbox Command Interface
    - Two Register SMI Source Interface
- Two ACPI Embedded Controller Interface
  - 1 or 4 Byte Data transfer capable
- ACPI Power Management Interface
  - SCI Event-Generating Functions
- Embedded Memory Interface
  - Host Serial IRQ Source
  - Provides Two Windows to On-Chip SRAM for Host Access
- Two Register Mailbox Command Interface
- Battery Backed (VCC0/VBAT) Resources
  - Power Fail Register
  - Power-Fail Status Register
  - Battery backed 64 byte memory
- Real Time Clock (RTC)
  - VCC0 (VBAT) Powered
  - 32KHz Crystal Oscillator
  - 32KHz Clock output available under VCC1 power
  - Time-of-Day and Calendar Registers
  - Programmable Alarms
  - Supports Leap Year and Daylight Savings Time
- Hibernation Timers
- General Purpose Analog to Digital Converter
  - 10-bit conversion precision
  - 10-bit conversion per channel is completed in less than 12us
  - 5 ADC channels
    - 10-bit Conversion with 2.9mV resolution
    - 0 to 3.3 VDC Conversion Range
  - Optional continuous sampling at a programmable rate
  - Internal Analog Voltage Reference (3.0V +/- 1%)
- Watch Dog Timer
- Four Programmable 16-bit and Two 32-bit Timers
  - Wake-capable Auto-reloading Timers
- Four Independent Hardware Driven PS/2 Ports
  - Fully functional on Main and/or Suspend Power
  - PS/2 Edge Wake Capable
- Four Programmable Pulse-Width Modulator Outputs
  - Independent Clock Rates
  - 16-Bit Duty Cycle Granularity
  - Operational in both Full on and Standby modes

# MEC1322

---

- Four EC-based SMBus 2.0 Host Controllers
  - Allows Master or Dual Slave Operation
  - Controllers are Fully Operational on Standby Power
  - DMA-driven I<sup>2</sup>C Network Layer Hardware
  - I<sup>2</sup>C Datalink Compatibility Mode
  - Multi-Master Capable
  - Supports Clock Stretching
  - Programmable Bus Speeds
    - 400 KHz Fast-mode Capable
    - 1 Mbps Fast-mode Plus Capable
  - Hardware Bus Access "Fairness" Interface
  - SMBus Time-outs Interface
  - 5 Ports
  - 2 Port Flexible Multiplexing
- PECl 3.0 Interface
- Keyboard Matrix Scan Interface
  - 18 x 8 Interrupt/Wake Capable Multiplexed Keyboard Scan Matrix
  - Row Pre-drive Option
- Four Breathing/Blinking LED Interfaces
  - Programmable Blink Rates
  - Piecewise Linear Breathing LED Output Controller
  - Operational in EC Sleep States
- Dual Fan Tachometer Inputs
- RPM-Based Fan Speed Control Algorithm
  - Utilizes one TACH input and one PWM output
  - 3% accurate from 500 RPM to 16k RPM
  - Automatic Tachometer feedback
  - Aging Fan or Invalid Drive Detection
  - Spin Up Routine
  - Ramp Rate Control
  - RPM-based Fan Speed Control Algorithm
- Fast GATEA20 & Fast CPU\_RESET
- RSMRST# Functionality Supporting System Deep Sleep
  - Compatible with south bridge SUSCLK/RSMRST# gating rules
  - Replacement 32K distribution available when RSMRST# is asserted
- Integrated Power-on Reset Generator
  - VCC1\_RST# open drain output
  - Accepts External driven Reset
- Anti-Glitch Protection on Power-on
- All Blocks Support Low Power Sleep Modes
- General Purpose Input/Output Pins
  - Low Power
  - High Configurability
- Two pin Debug Port with standard 16C550A register interface
  - Accessible from both Host and EC
- BC-Link Interconnection Bus
  - One High Speed Bus Master Controller
- Package Options
  - 128-pin VTQFP
  - 132-pin DQFN
  - 144-pin WFBGA

## Description

The MEC1322 incorporates a high-performance 32-bit ARM® Cortex®-M4 embedded microcontroller with 128 Kilobytes of SRAM and 32 Kilobytes of Boot ROM. It communicates with the system host using the Intel® Low Pin Count (LPC) bus.

The MEC1322 has two SPI memory interfaces that allow the EC to read its code from external SPI flash memory: private SPI and/or shared SPI. The Shared SPI interface allows for EC code to be stored in a shared SPI chip along with the system BIOS. The private SPI memory interface provides for a dedicated SPI flash that is only accessible by the EC.

The MEC1322 provides support for loading EC code from the private or shared SPI flash device on a VCC1 power-on. Before executing the EC code loaded from a SPI Flash Device, the MEC1322 validates the EC code using a digital signature encoded according to PKCS #1. The signature uses RSA-2048 encryption and SHA-256 hashing. This provides automated detection of invalid EC code that may be a result of malicious or accidental corruption. It occurs before each boot of the host processor, thereby ensuring a HW based root of trust not easily thwarted via physical replacement attack.

The MEC1322 is directly powered by two separate suspend supply planes (VBAT and VCC1) and senses the runtime power plane (VCC) to provide "Instant On" and system power management functions. It also contains an integrated VCC1 Reset Interface and a system Power Management Interface that supports low-power states and can drive state changes as a result of hardware wake events.

## TO OUR VALUED CUSTOMERS

It is our intention to provide our valued customers with the best documentation possible to ensure successful use of your Microchip products. To this end, we will continue to improve our publications to better suit your needs. Our publications will be refined and enhanced as new volumes and updates are introduced.

If you have any questions or comments regarding this publication, please contact the Marketing Communications Department via E-mail at [docerrors@microchip.com](mailto:docerrors@microchip.com). We welcome your feedback.

### Most Current Data Sheet

To obtain the most up-to-date version of this data sheet, please register at our Worldwide Web site at:

<http://www.microchip.com>

You can determine the version of a data sheet by examining its literature number found on the bottom outside corner of any page. The last character of the literature number is the version number, (e.g., DS3000000A is version A of document DS3000000).

### Errata

An errata sheet, describing minor operational differences from the data sheet and recommended workarounds, may exist for current devices. As device/documentation issues become known to us, we will publish an errata sheet. The errata will specify the revision of silicon and revision of document to which it applies.

To determine if an errata sheet exists for a particular device, please check with one of the following:

- Microchip's Worldwide Web site; <http://www.microchip.com>
- Your local Microchip sales office (see last page)

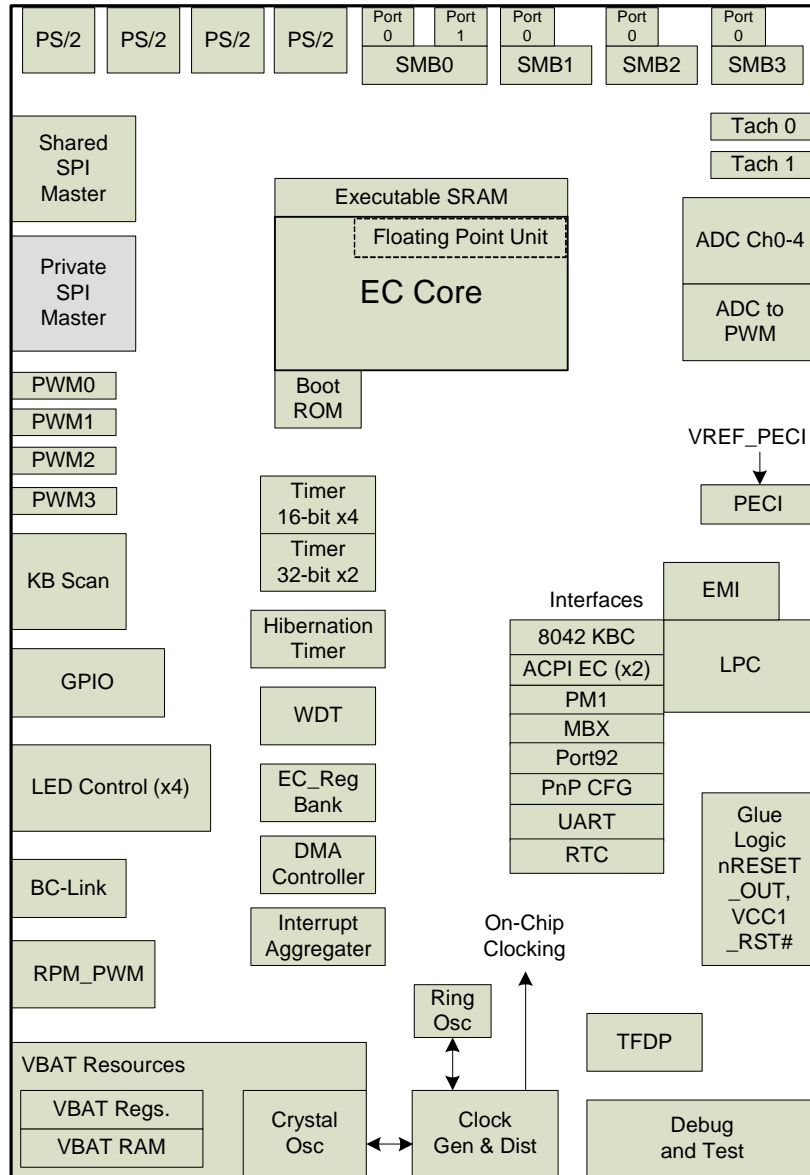
When contacting a sales office, please specify which device, revision of silicon and data sheet (include -literature number) you are using.

### Customer Notification System

Register on our web site at [www.microchip.com](http://www.microchip.com) to receive the most current information on all of our products.

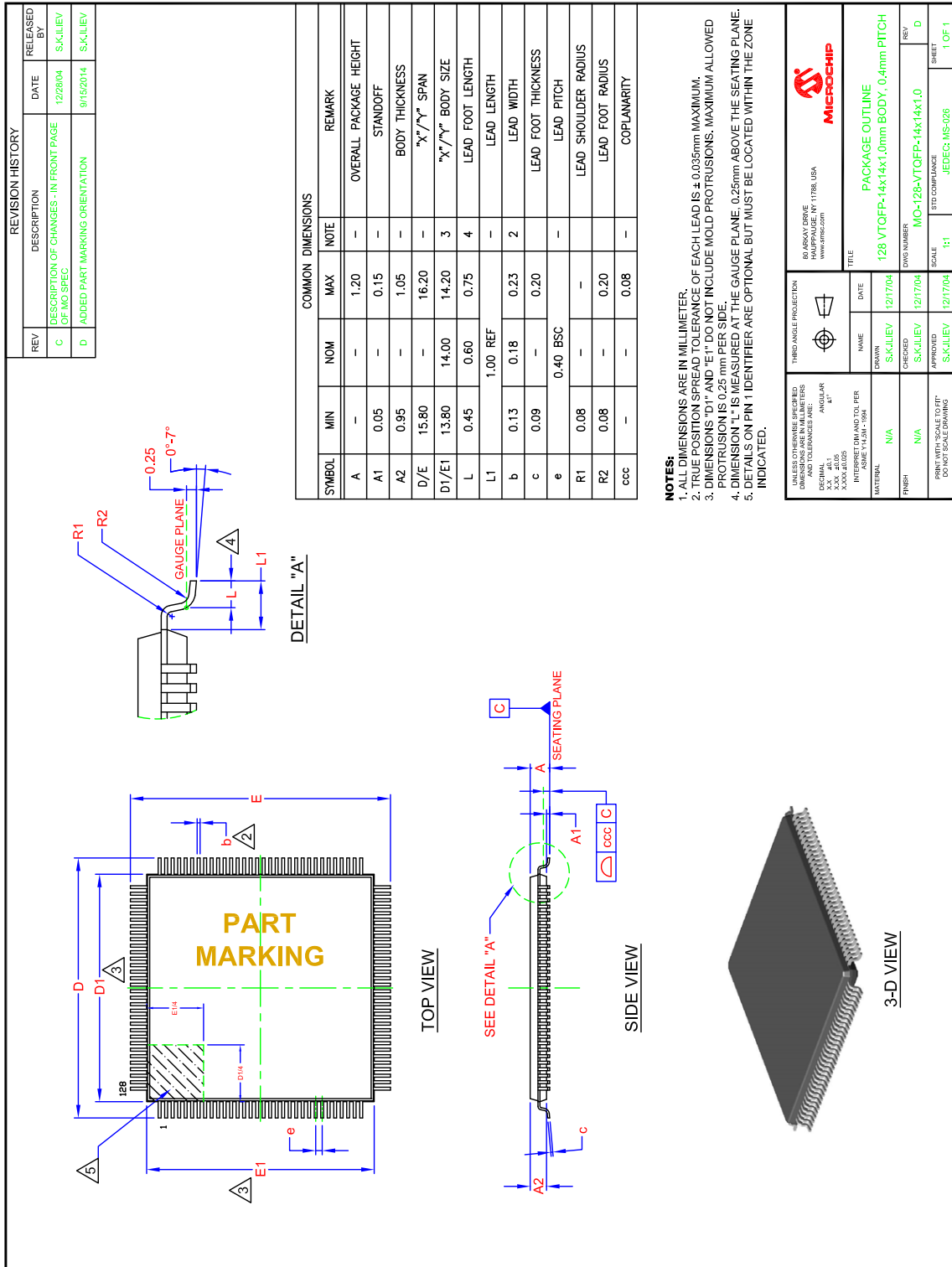
# MEC1322

## BLOCK DIAGRAM



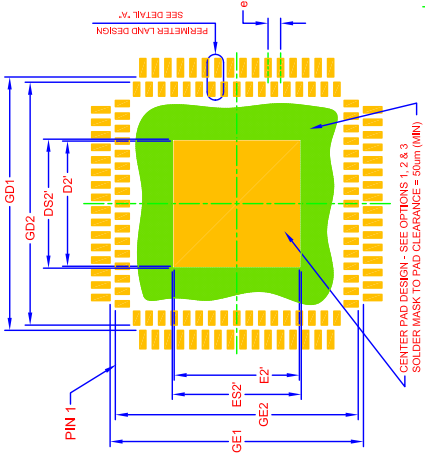
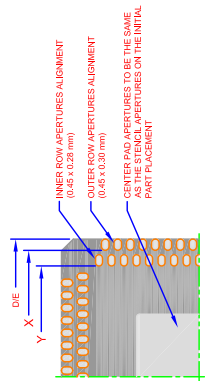
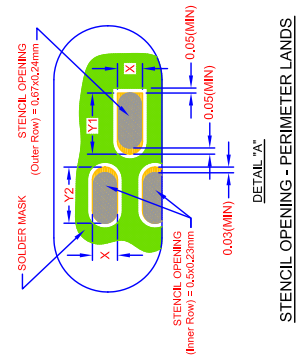
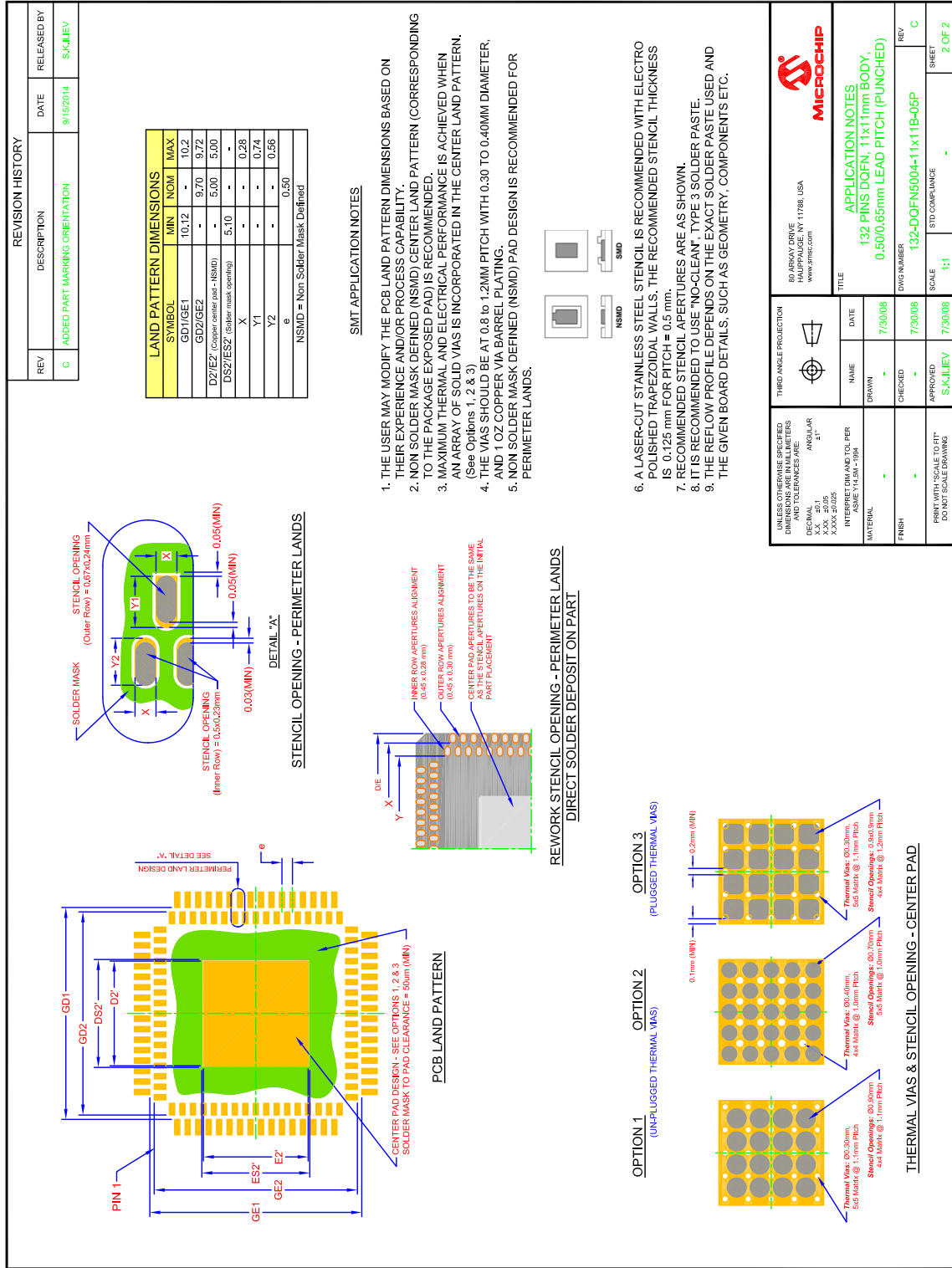
## PACKAGE OUTLINE

FIGURE 1: 128-PIN VTQFP PACKAGE OUTLINE



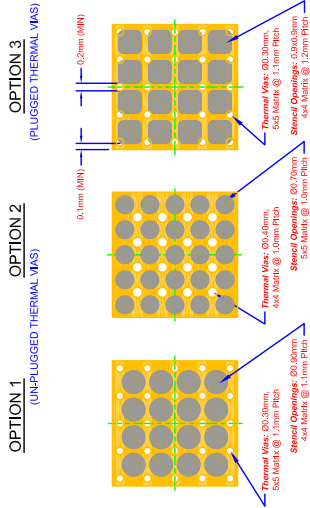


**FIGURE 3: 132-PIN DQFN PACKAGE OUTLINE (2 OF 2)**



**PCB LAND PATTERN**

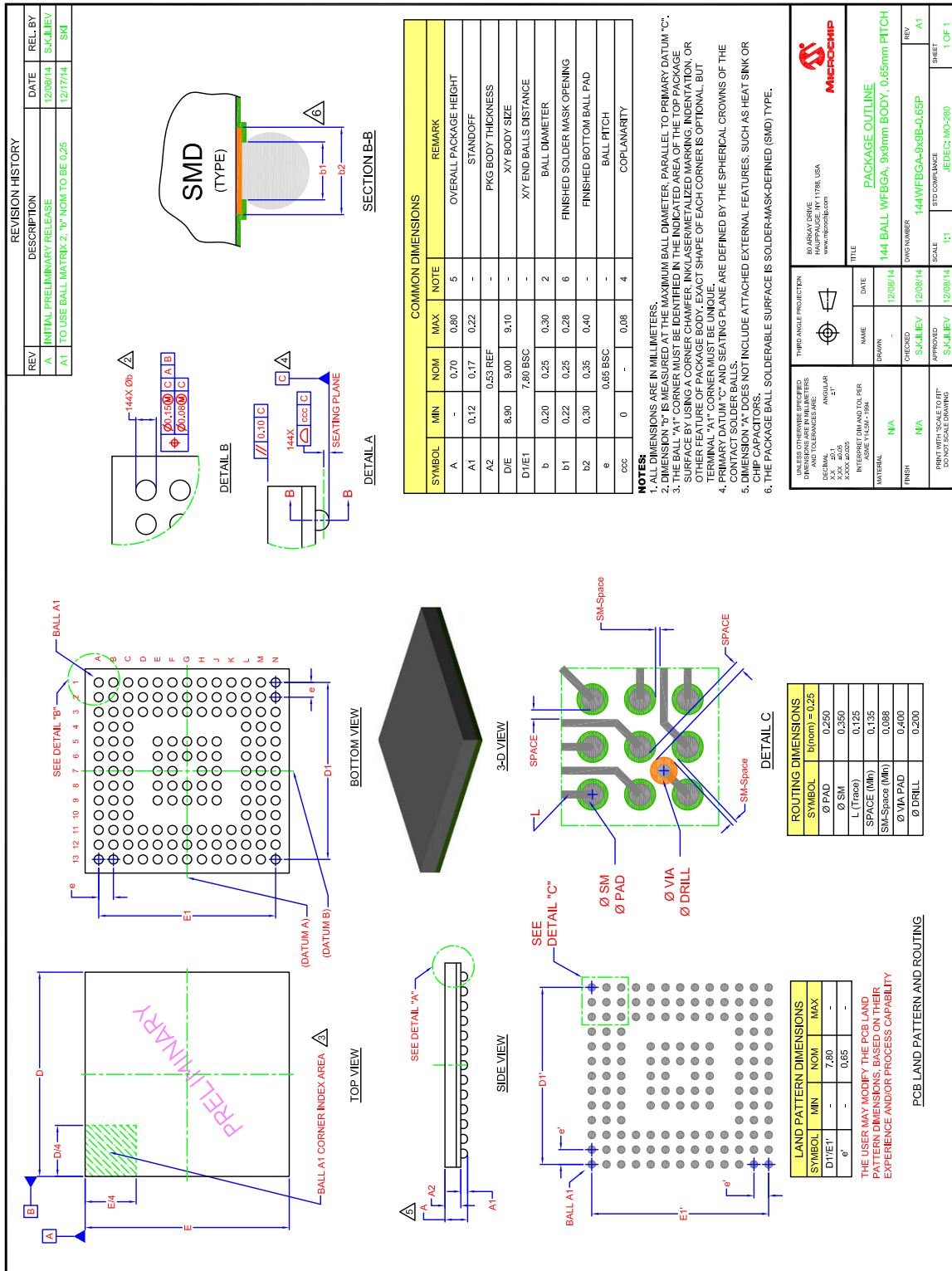
**REWORK STENCIL OPENING - PERIMETER LANDS  
DIRECT SOLDER DEPOSIT ON PART**



**THERMAL VIAS & STENCIL OPENING - CENTER PAD**

6. A LASER-CUT STAINLESS STEEL STENCIL IS RECOMMENDED WITH ELECTRO POLISHED TRAPEZOIDAL WALLS. THE RECOMMENDED STENCIL THICKNESS IS 0.125 mm FOR PITCH = 0.5 mm.
7. RECOMMENDED STENCIL APERTURES ARE AS SHOWN.
8. IT IS RECOMMENDED TO USE "NO-CLEAN", TYPE 3 SOLDER PASTE.
9. THE REFLOW PROFILE DEPENDS ON THE EXACT SOLDER PASTE USED AND THE GIVEN BOARD DETAILS, SUCH AS GEOMETRY, COMPONENTS ETC.

FIGURE 4: 144-PIN PACKAGE OUTLINE





## APPENDIX A: PRODUCT BRIEF REVISION HISTORY

TABLE A-1: REVISION HISTORY

Revision	Section/Figure/Entry	Correction
DS00001733B (06-19-15)	Document Features, Product Identification System page, Package Outlines	144-pin WFBGA package added
DS00001733A (05-05-14)	Document Release	

## THE MICROCHIP WEB SITE

Microchip provides online support via our WWW site at [www.microchip.com](http://www.microchip.com). This web site is used as a means to make files and information easily available to customers. Accessible by using your favorite Internet browser, the web site contains the following information:

- **Product Support** – Data sheets and errata, application notes and sample programs, design resources, user's guides and hardware support documents, latest software releases and archived software
- **General Technical Support** – Frequently Asked Questions (FAQ), technical support requests, online discussion groups, Microchip consultant program member listing
- **Business of Microchip** – Product selector and ordering guides, latest Microchip press releases, listing of seminars and events, listings of Microchip sales offices, distributors and factory representatives

## CUSTOMER CHANGE NOTIFICATION SERVICE

Microchip's customer notification service helps keep customers current on Microchip products. Subscribers will receive e-mail notification whenever there are changes, updates, revisions or errata related to a specified product family or development tool of interest.

To register, access the Microchip web site at [www.microchip.com](http://www.microchip.com). Under "Support", click on "Customer Change Notification" and follow the registration instructions.

## CUSTOMER SUPPORT

Users of Microchip products can receive assistance through several channels:

- Distributor or Representative
- Local Sales Office
- Field Application Engineer (FAE)
- Technical Support

Customers should contact their distributor, representative or field application engineer (FAE) for support. Local sales offices are also available to help customers. A listing of sales offices and locations is included in the back of this document.

**Technical support is available through the web site at: <http://www.microchip.com/support>**

## PRODUCT IDENTIFICATION SYSTEM

To order or obtain information, e.g., on pricing or delivery, refer to the factory or the listed sales office.

<u>PART NO.</u> <sup>(1)</sup>	-	<u>XXX</u> <sup>(2)</sup>	-	<u>XX</u>	-	<u>[X]</u> <sup>(3)</sup>
Device		Package		ROM Version		Tape and Reel Option
<p>Device: MEC1322<sup>(1)</sup></p> <p>Package: NU = 128 pin VTQFP<sup>(2)</sup> LZY = 132 pin DQFN<sup>(2)</sup> SZ = 144 pin WFBGA<sup>(2)</sup></p> <p>ROM Version: C0 = Standard ROM</p> <p>Tape and Reel Option: Blank = Tray packaging TR = Tape and Reel<sup>(3)</sup></p>						
<p><b>Examples:</b></p> <p>a) MEC1322-NU-C0 = 128-pin VTQFP b) MEC1322-LZY-C0 = 132-pin DQFN c) MEC1322-SZ = 144-pin WFBGA</p> <p><b>Note 1:</b> These products meet the halogen maximum concentration values per IEC61249-2-21.</p> <p><b>Note 2:</b> All package options are RoHS compliant. For RoHS compliance and environmental information, please visit <a href="http://www.microchip.com/pagehandler/en-us/aboutus/ehs.html">http://www.microchip.com/pagehandler/en-us/aboutus/ehs.html</a>.</p> <p><b>Note 3:</b> Tape and Reel identifier only appears in the catalog part number description. This identifier is used for ordering purposes and is not printed on the device package. Check with your Microchip Sales Office for package availability with the Tape and Reel option.</p>						

---

---

**Note the following details of the code protection feature on Microchip devices:**

- Microchip products meet the specification contained in their particular Microchip Data Sheet.
- Microchip believes that its family of products is one of the most secure families of its kind on the market today, when used in the intended manner and under normal conditions.
- There are dishonest and possibly illegal methods used to breach the code protection feature. All of these methods, to our knowledge, require using the Microchip products in a manner outside the operating specifications contained in Microchip's Data Sheets. Most likely, the person doing so is engaged in theft of intellectual property.
- Microchip is willing to work with the customer who is concerned about the integrity of their code.
- Neither Microchip nor any other semiconductor manufacturer can guarantee the security of their code. Code protection does not mean that we are guaranteeing the product as “unbreakable.”

Code protection is constantly evolving. We at Microchip are committed to continuously improving the code protection features of our products. Attempts to break Microchip's code protection feature may be a violation of the Digital Millennium Copyright Act. If such acts allow unauthorized access to your software or other copyrighted work, you may have a right to sue for relief under that Act.

Information contained in this publication regarding device applications and the like is provided only for your convenience and may be superseded by updates. It is your responsibility to ensure that your application meets with your specifications. MICROCHIP MAKES NO REPRESENTATIONS OR WARRANTIES OF ANY KIND WHETHER EXPRESS OR IMPLIED, WRITTEN OR ORAL, STATUTORY OR OTHERWISE, RELATED TO THE INFORMATION, INCLUDING BUT NOT LIMITED TO ITS CONDITION, QUALITY, PERFORMANCE, MERCHANTABILITY OR FITNESS FOR PURPOSE. Microchip disclaims all liability arising from this information and its use. Use of Microchip devices in life support and/or safety applications is entirely at the buyer's risk, and the buyer agrees to defend, indemnify and hold harmless Microchip from any and all damages, claims, suits, or expenses resulting from such use. No licenses are conveyed, implicitly or otherwise, under any Microchip intellectual property rights unless otherwise stated.

**Trademarks**

The Microchip name and logo, the Microchip logo, dsPIC, FlashFlex, flexPWR, JukeBlox, KEELOQ, KEELOQ logo, Kleer, LANCheck, MediaLB, MOST, MOST logo, MPLAB, OptoLyzer, PIC, PICSTART, PIC<sup>32</sup> logo, RightTouch, SpyNIC, SST, SST Logo, SuperFlash and UNI/O are registered trademarks of Microchip Technology Incorporated in the U.S.A. and other countries.

The Embedded Control Solutions Company and mTouch are registered trademarks of Microchip Technology Incorporated in the U.S.A.

Analog-for-the-Digital Age, BodyCom, chipKIT, chipKIT logo, CodeGuard, dsPICDEM, dsPICDEM.net, ECAN, In-Circuit Serial Programming, ICSP, Inter-Chip Connectivity, KleerNet, KleerNet logo, MiWi, MPASM, MPF, MPLAB Certified logo, MPLIB, MPLINK, MultiTRAK, NetDetach, Omniscient Code Generation, PICDEM, PICDEM.net, PICKit, PICtail, RightTouch logo, REAL ICE, SQI, Serial Quad I/O, Total Endurance, TSHARC, USBCheck, VariSense, ViewSpan, WiperLock, Wireless DNA, and ZENA are trademarks of Microchip Technology Incorporated in the U.S.A. and other countries.

SQTP is a service mark of Microchip Technology Incorporated in the U.S.A.

Silicon Storage Technology is a registered trademark of Microchip Technology Inc. in other countries.

GestIC is a registered trademarks of Microchip Technology Germany II GmbH & Co. KG, a subsidiary of Microchip Technology Inc., in other countries.

All other trademarks mentioned herein are property of their respective companies.

© 2014 - 2015, Microchip Technology Incorporated, Printed in the U.S.A., All Rights Reserved.

ISBN: 9781632775078

**QUALITY MANAGEMENT SYSTEM**  
**CERTIFIED BY DNV**  
**== ISO/TS 16949 ==**

*Microchip received ISO/TS-16949:2009 certification for its worldwide headquarters, design and wafer fabrication facilities in Chandler and Tempe, Arizona; Gresham, Oregon and design centers in California and India. The Company's quality system processes and procedures are for its PIC<sup>®</sup> MCUs and dsPIC<sup>®</sup> DSCs, KEELOQ<sup>®</sup> code hopping devices, Serial EEPROMs, microperipherals, nonvolatile memory and analog products. In addition, Microchip's quality system for the design and manufacture of development systems is ISO 9001:2000 certified.*



# MICROCHIP

## Worldwide Sales and Service

### AMERICAS

**Corporate Office**  
2355 West Chandler Blvd.  
Chandler, AZ 85224-6199  
Tel: 480-792-7200  
Fax: 480-792-7277  
Technical Support:  
<http://www.microchip.com/support>

Web Address:  
[www.microchip.com](http://www.microchip.com)

**Atlanta**  
Duluth, GA  
Tel: 678-957-9614  
Fax: 678-957-1455

**Austin, TX**  
Tel: 512-257-3370

**Boston**  
Westborough, MA  
Tel: 774-760-0087  
Fax: 774-760-0088

**Chicago**  
Itasca, IL  
Tel: 630-285-0071  
Fax: 630-285-0075

**Cleveland**  
Independence, OH  
Tel: 216-447-0464  
Fax: 216-447-0643

**Dallas**  
Addison, TX  
Tel: 972-818-7423  
Fax: 972-818-2924

**Detroit**  
Novi, MI  
Tel: 248-848-4000

**Houston, TX**  
Tel: 281-894-5983

**Indianapolis**  
Noblesville, IN  
Tel: 317-773-8323  
Fax: 317-773-5453

**Los Angeles**  
Mission Viejo, CA  
Tel: 949-462-9523  
Fax: 949-462-9608

**New York, NY**  
Tel: 631-435-6000

**San Jose, CA**  
Tel: 408-735-9110

**Canada - Toronto**  
Tel: 905-673-0699  
Fax: 905-673-6509

### ASIA/PACIFIC

**Asia Pacific Office**  
Suites 3707-14, 37th Floor  
Tower 6, The Gateway  
Harbour City, Kowloon  
Hong Kong  
Tel: 852-2943-5100  
Fax: 852-2401-3431

**Australia - Sydney**  
Tel: 61-2-9868-6733  
Fax: 61-2-9868-6755

**China - Beijing**  
Tel: 86-10-8569-7000  
Fax: 86-10-8528-2104

**China - Chengdu**  
Tel: 86-28-8665-5511  
Fax: 86-28-8665-7889

**China - Chongqing**  
Tel: 86-23-8980-9588  
Fax: 86-23-8980-9500

**China - Dongguan**  
Tel: 86-769-8702-9880

**China - Hangzhou**  
Tel: 86-571-8792-8115  
Fax: 86-571-8792-8116

**China - Hong Kong SAR**  
Tel: 852-2943-5100  
Fax: 852-2401-3431

**China - Nanjing**  
Tel: 86-25-8473-2460  
Fax: 86-25-8473-2470

**China - Qingdao**  
Tel: 86-532-8502-7355  
Fax: 86-532-8502-7205

**China - Shanghai**  
Tel: 86-21-5407-5533  
Fax: 86-21-5407-5066

**China - Shenyang**  
Tel: 86-24-2334-2829  
Fax: 86-24-2334-2393

**China - Shenzhen**  
Tel: 86-755-8864-2200  
Fax: 86-755-8203-1760

**China - Wuhan**  
Tel: 86-27-5980-5300  
Fax: 86-27-5980-5118

**China - Xian**  
Tel: 86-29-8833-7252  
Fax: 86-29-8833-7256

### ASIA/PACIFIC

**China - Xiamen**  
Tel: 86-592-2388138  
Fax: 86-592-2388130

**China - Zhuhai**  
Tel: 86-756-3210040  
Fax: 86-756-3210049

**India - Bangalore**  
Tel: 91-80-3090-4444  
Fax: 91-80-3090-4123

**India - New Delhi**  
Tel: 91-11-4160-8631  
Fax: 91-11-4160-8632

**India - Pune**  
Tel: 91-20-3019-1500

**Japan - Osaka**  
Tel: 81-6-6152-7160  
Fax: 81-6-6152-9310

**Japan - Tokyo**  
Tel: 81-3-6880-3770  
Fax: 81-3-6880-3771

**Korea - Daegu**  
Tel: 82-53-744-4301  
Fax: 82-53-744-4302

**Korea - Seoul**  
Tel: 82-2-554-7200  
Fax: 82-2-558-5932 or  
82-2-558-5934

**Malaysia - Kuala Lumpur**  
Tel: 60-3-6201-9857  
Fax: 60-3-6201-9859

**Malaysia - Penang**  
Tel: 60-4-227-8870  
Fax: 60-4-227-4068

**Philippines - Manila**  
Tel: 63-2-634-9065  
Fax: 63-2-634-9069

**Singapore**  
Tel: 65-6334-8870  
Fax: 65-6334-8850

**Taiwan - Hsin Chu**  
Tel: 886-3-5778-366  
Fax: 886-3-5770-955

**Taiwan - Kaohsiung**  
Tel: 886-7-213-7828

**Taiwan - Taipei**  
Tel: 886-2-2508-8600  
Fax: 886-2-2508-0102

**Thailand - Bangkok**  
Tel: 66-2-694-1351  
Fax: 66-2-694-1350

### EUROPE

**Austria - Wels**  
Tel: 43-7242-2244-39  
Fax: 43-7242-2244-393

**Denmark - Copenhagen**  
Tel: 45-4450-2828  
Fax: 45-4485-2829

**France - Paris**  
Tel: 33-1-69-53-63-20  
Fax: 33-1-69-30-90-79

**Germany - Dusseldorf**  
Tel: 49-2129-3766400

**Germany - Munich**  
Tel: 49-89-627-144-0  
Fax: 49-89-627-144-44

**Germany - Pforzheim**  
Tel: 49-7231-424750

**Italy - Milan**  
Tel: 39-0331-742611  
Fax: 39-0331-466781

**Italy - Venice**  
Tel: 39-049-7625286

**Netherlands - Drunen**  
Tel: 31-416-690399  
Fax: 31-416-690340

**Poland - Warsaw**  
Tel: 48-22-3325737

**Spain - Madrid**  
Tel: 34-91-708-08-90  
Fax: 34-91-708-08-91

**Sweden - Stockholm**  
Tel: 46-8-5090-4654

**UK - Wokingham**  
Tel: 44-118-921-5800  
Fax: 44-118-921-5820

01/27/15