

Dual P-Channel Enhancement Mode MOSFET

### Features

- -30V/-9A,  
 $R_{DS(ON)} = 15m\Omega$  (typ.) @  $V_{GS} = -10V$   
 $R_{DS(ON)} = 28m\Omega$  (typ.) @  $V_{GS} = -4.5V$
- Super High Dense Cell Design
- Reliable and Rugged
- Lead Free and Green Devices Available (RoHS Compliant)

### Pin Description

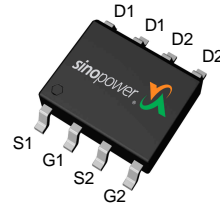

Top View of SOP-8

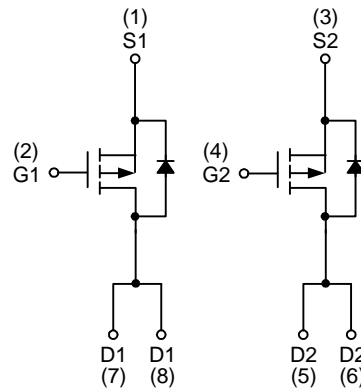

P-Channel MOSFET

### Applications

- Power Management in MB/NB DC-DC Converter Application.

### Ordering and Marking Information

<p>APM4927 □□-□□ □</p> <pre>     □□-□□ □                            --- Assembly Material              --- Handling Code              --- Temperature Range              --- Package Code                 </pre>	<p>Package Code K : SOP-8</p> <p>Operating Junction Temperature Range C : -55 to 150 °C</p> <p>Handling Code TR : Tape &amp; Reel</p> <p>Assembly Material G : Halogen and Lead Free Device</p>
<p>APM4927 K : <span style="border: 1px solid black; padding: 2px;">APM4927 XXXXX ●</span></p>	<p>XXXXXX - Date Code</p>

Note : SINOPOWER lead-free products contain molding compounds/die attach materials and 100% matte tin plate termination finish; which are fully compliant with RoHS. SINOPOWER lead-free products meet or exceed the lead-free requirements of IPC/JEDEC J-STD-020D for MSL classification at lead-free peak reflow temperature. SINOPOWER defines "Green" to mean lead-free (RoHS compliant) and halogen free (Br or Cl does not exceed 900ppm by weight in homogeneous material and total of Br and Cl does not exceed 1500ppm by weight).

SINOPOWER reserves the right to make changes to improve reliability or manufacturability without notice, and advise customers to obtain the latest version of relevant information to verify before placing orders.

## Absolute Maximum Ratings ( $T_A = 25^\circ\text{C}$ unless otherwise noted)

Symbol	Parameter	Rating	Unit	
$V_{DSS}$	Drain-Source Voltage	-30	V	
$V_{GSS}$	Gate-Source Voltage	$\pm 25$		
$I_D^a$	Continuous Drain Current	$T_A=25^\circ\text{C}$	-9	A
		$T_A=70^\circ\text{C}$	-7.5	
$I_{DM}^a$	Pulsed Drain Current	$V_{GS}=-10\text{V}$	-35	
$I_S^a$	Diode Continuous Forward Current		-2.5	
$I_{AR}^b$	Avalanche Current		-25	
$E_{AR}^b$	Repetitive Avalanche Energy (L=0.3mH)		94	mJ
$T_J$	Maximum Junction Temperature		150	$^\circ\text{C}$
$T_{STG}$	Storage Temperature Range		-55 to 150	
$P_D^a$	Maximum Power Dissipation	$T_A=25^\circ\text{C}$	2.5	W
		$T_A=70^\circ\text{C}$	1.6	
$R_{\theta JA}^{a,c}$	Thermal Resistance-Junction to Ambient	$t \leq 10\text{s}$	50	$^\circ\text{C/W}$
$R_{\theta JL}$	Thermal Resistance-Junction to Lead	Steady State	25	

Note a : Surface Mounted on  $1\text{in}^2$  pad area,  $t \leq 10\text{sec}$ .

Note b : UIS tested and pulse width limited by maximum junction temperature  $150^\circ\text{C}$  (initial temperature  $T_J=25^\circ\text{C}$ ).

Note c : Maximum under Steady State conditions is  $75^\circ\text{C/W}$ .

## Electrical Characteristics ( $T_A = 25^\circ\text{C}$ unless otherwise noted)

Symbol	Parameter	Test Conditions	APM4927K			Unit
			Min.	Typ.	Max.	
<b>Static Characteristics</b>						
$BV_{DSS}$	Drain-Source Breakdown Voltage	$V_{GS}=0\text{V}, I_{DS}=-250\mu\text{A}$	-30	-	-	V
$I_{DSS}$	Zero Gate Voltage Drain Current	$V_{DS}=-24\text{V}, V_{GS}=0\text{V}$	-	-	-1	$\mu\text{A}$
		$T_J=85^\circ\text{C}$	-	-	-30	
$V_{GS(th)}$	Gate Threshold Voltage	$V_{DS}=V_{GS}, I_{DS}=-250\mu\text{A}$	-1	-2	-2.5	V
$I_{GSS}$	Gate Leakage Current	$V_{GS}=\pm 25\text{V}, V_{DS}=0\text{V}$	-	-	$\pm 100$	nA
$R_{DS(ON)}^d$	Drain-Source On-state Resistance	$V_{GS}=-10\text{V}, I_{DS}=-9\text{A}$	-	15	19	m $\Omega$
		$V_{GS}=-4.5\text{V}, I_{DS}=-6.5\text{A}$	-	28	37	
<b>Diode Characteristics</b>						
$V_{SD}^d$	Diode Forward Voltage	$I_{SD}=-2.5\text{A}, V_{GS}=0\text{V}$	-	-0.75	-1.1	V
$t_{rr}^e$	Reverse Recovery Time	$I_{SD}=-9\text{A}, dI_{SD}/dt=100\text{A}/\mu\text{s}$	-	20	-	ns
$Q_{rr}^e$	Reverse Recovery Charge		-	11	-	nC

## Electrical Characteristics (Cont.) ( $T_A = 25^\circ\text{C}$ unless otherwise noted)

Symbol	Parameter	Test Conditions	APM4927K			Unit
			Min.	Typ.	Max.	
<b>Dynamic Characteristics<sup>e</sup></b>						
$R_G$	Gate Resistance	$V_{GS}=0V, V_{DS}=0V, F=1\text{MHz}$	3	5	7	$\Omega$
$C_{iss}$	Input Capacitance	$V_{GS}=0V,$ $V_{DS}=-15V,$ Frequency=1.0MHz	-	2070	-	pF
$C_{oss}$	Output Capacitance		-	320	-	
$C_{riss}$	Reverse Transfer Capacitance		-	250	-	
$t_{d(ON)}$	Turn-on Delay Time	$V_{DD}=-15V, R_L=15\Omega,$ $I_{DS}=-1A, V_{GEN}=-10V,$ $R_G=6\Omega$	-	13	24	ns
$t_r$	Turn-on Rise Time		-	13	24	
$t_{d(OFF)}$	Turn-off Delay Time		-	59	107	
$t_f$	Turn-off Fall Time		-	29	53	
<b>Gate Charge Characteristics<sup>e</sup></b>						
$Q_g$	Total Gate Charge	$V_{DS}=-15V, V_{GS}=-10V,$ $I_{DS}=-9A$	-	35	50	nC
$Q_{gs}$	Gate-Source Charge		-	4.7	-	
$Q_{gd}$	Gate-Drain Charge		-	9.3	-	

Note d : Pulse test ; pulse width $\leq 300\mu\text{s}$ , duty cycle $\leq 2\%$ .

Note e : Guaranteed by design, not subject to production testing.

Typical Operating Characteristics

Power Dissipation

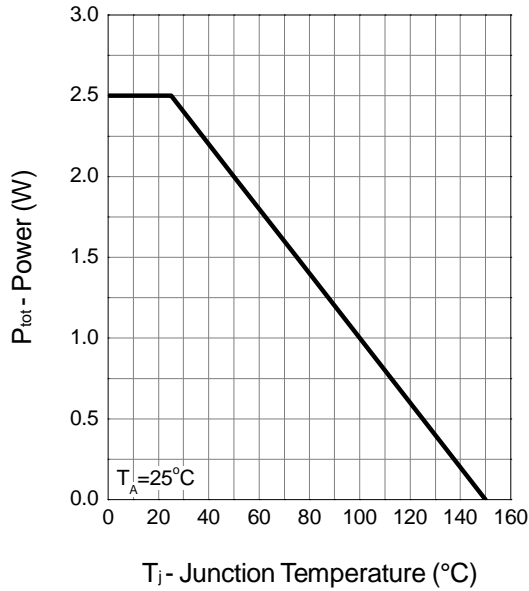

Drain Current

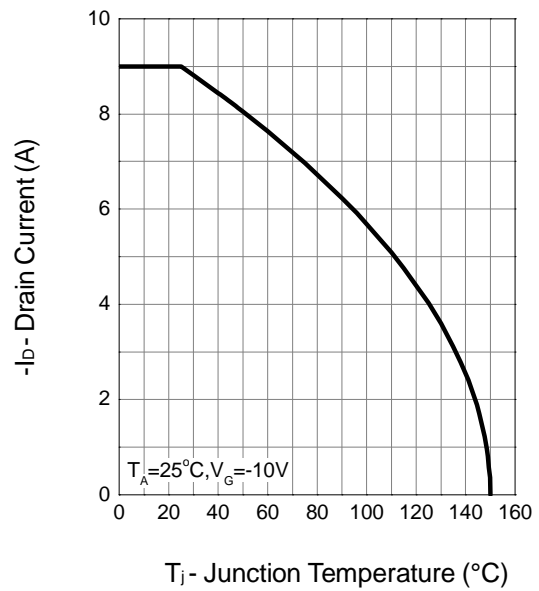

Safe Operation Area

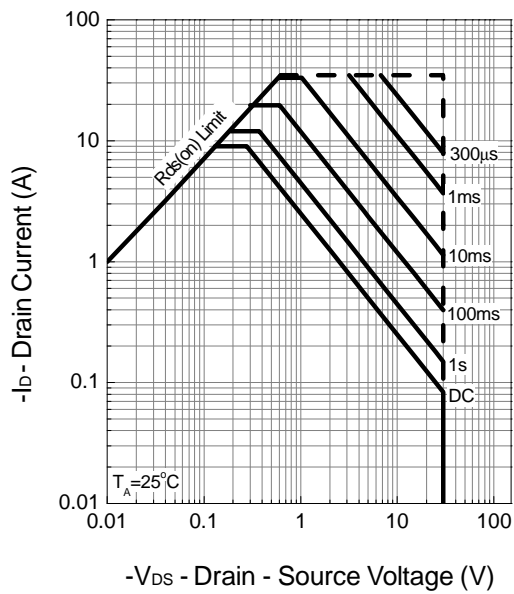

Thermal Transient Impedance

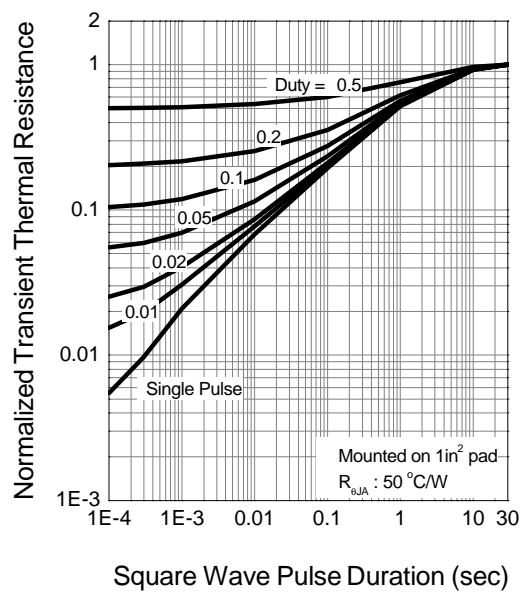

Typical Operating Characteristics (Cont.)

Output Characteristics

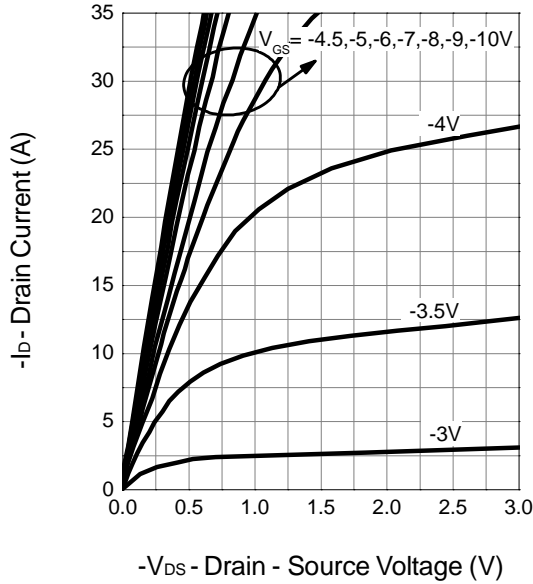

Drain-Source On Resistance

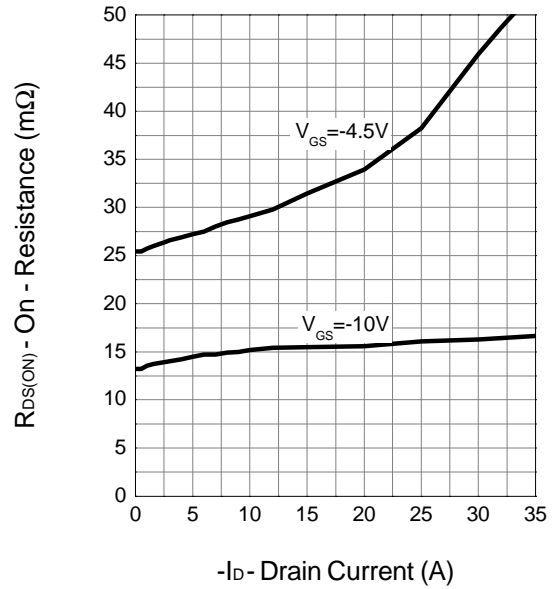

Gate-Source On Resistance

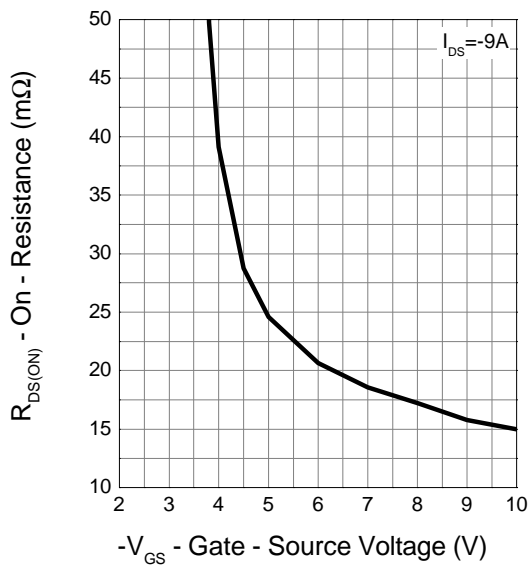

Gate Threshold Voltage

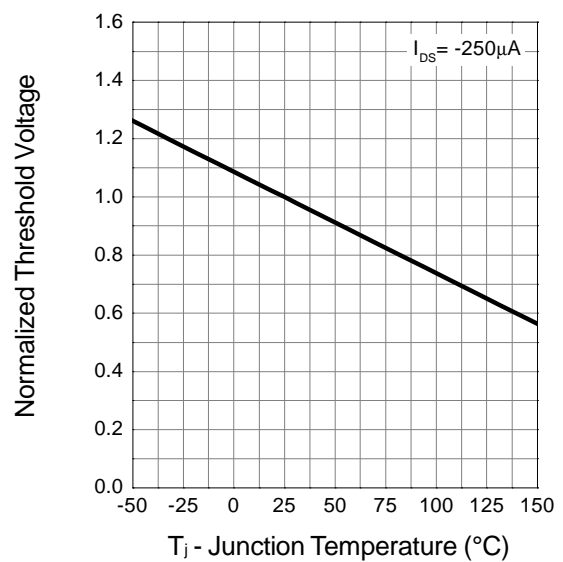

Typical Operating Characteristics (Cont.)

Drain-Source On Resistance

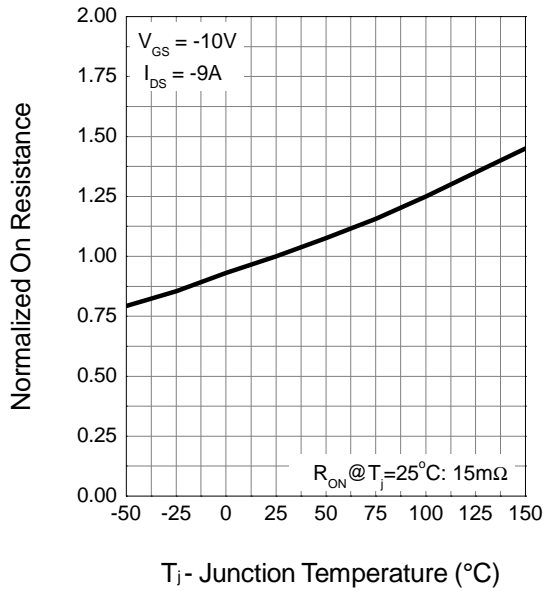

Source-Drain Diode Forward

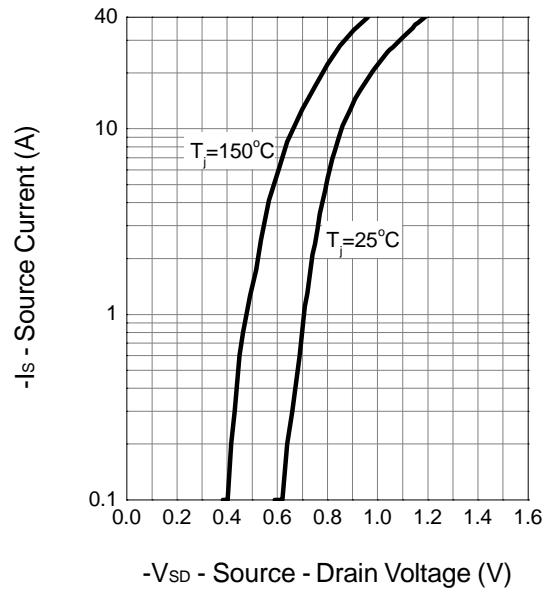

Capacitance

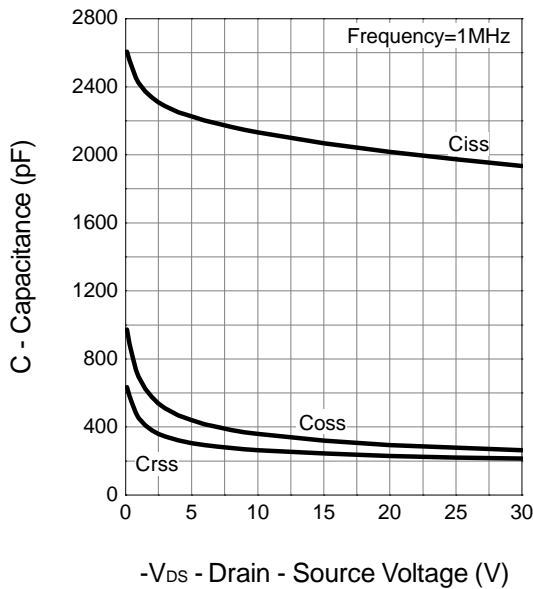

Gate Charge

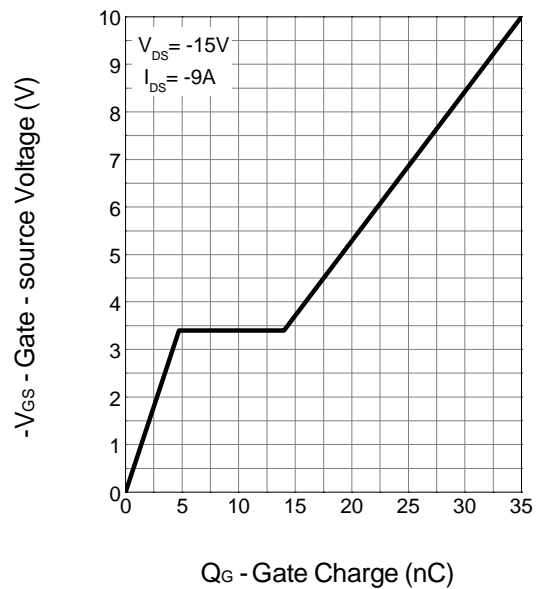

Package Information

SOP-8

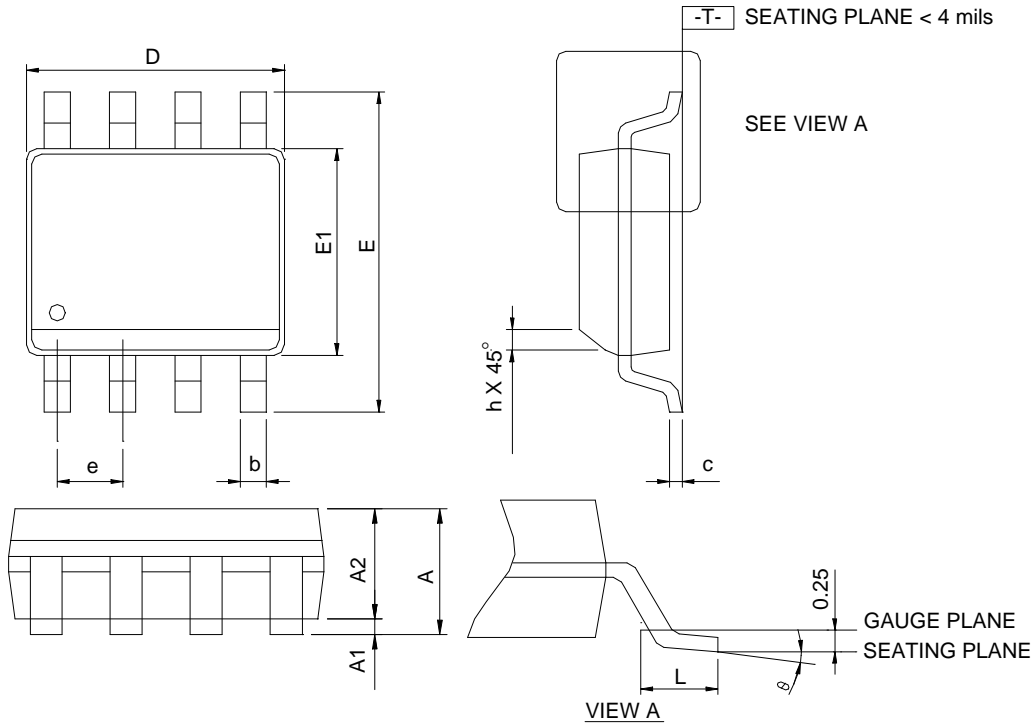

SYMBOL	SOP-8			
	MILLIMETERS		INCHES	
	MIN.	MAX.	MIN.	MAX.
A		1.75		0.069
A1	0.10	0.25	0.004	0.010
A2	1.25		0.049	
b	0.31	0.51	0.012	0.020
c	0.17	0.25	0.007	0.010
D	4.80	5.00	0.189	0.197
E	5.80	6.20	0.228	0.244
E1	3.80	4.00	0.150	0.157
e	1.27 BSC		0.050 BSC	
h	0.25	0.50	0.010	0.020
L	0.40	1.27	0.016	0.050
θ	0°	8°	0°	8°

- Note: 1. Follow JEDEC MS-012 AA.  
 2. Dimension "D" does not include mold flash, protrusions or gate burrs. Mold flash, protrusion or gate burrs shall not exceed 6 mil per side.  
 3. Dimension "E" does not include inter-lead flash or protrusions. Inter-lead flash and protrusions shall not exceed 10 mil per side.

### Carrier Tape & Reel Dimensions

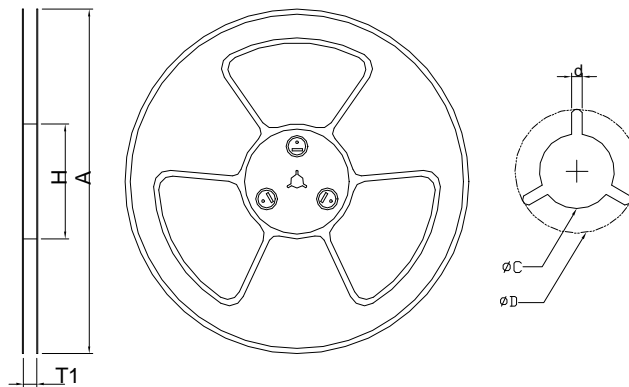
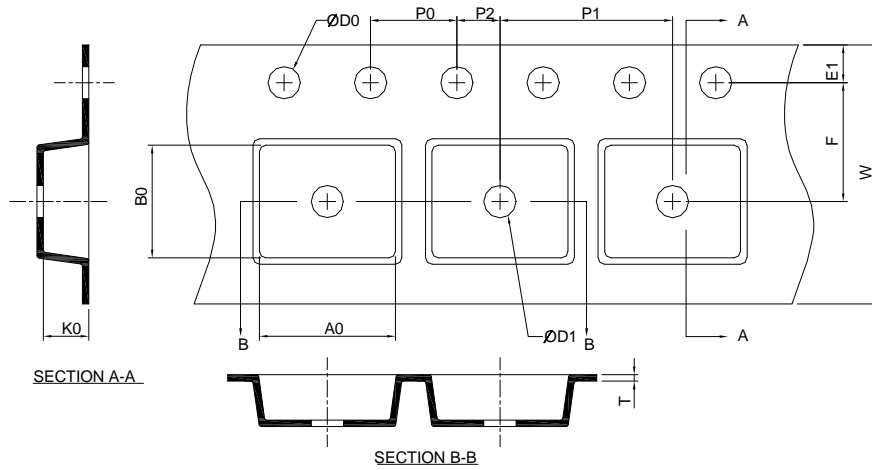

Application	A	H	T1	C	d	D	W	E1	F
SOP-8	330.0 ±0.00	50 MIN.	12.4+2.00 -0.00	13.0+0.50 -0.20	1.5 MIN.	20.2 MIN.	12.0 ±0.30	1.75 ±0.10	5.5 ±0.05
	P0	P1	P2	D0	D1	T	A0	B0	K0
	4.0 ±0.10	8.0 ±0.10	2.0 ±0.05	1.5+0.10 -0.00	1.5 MIN.	0.6+0.00 -0.40	6.40 ±0.20	5.20 ±0.20	2.10 ±0.20

(mm)

### Devices Per Unit

Package Type	Unit	Quantity
SOP-8	Tape & Reel	2500



## Taping Direction Information

SOP-8

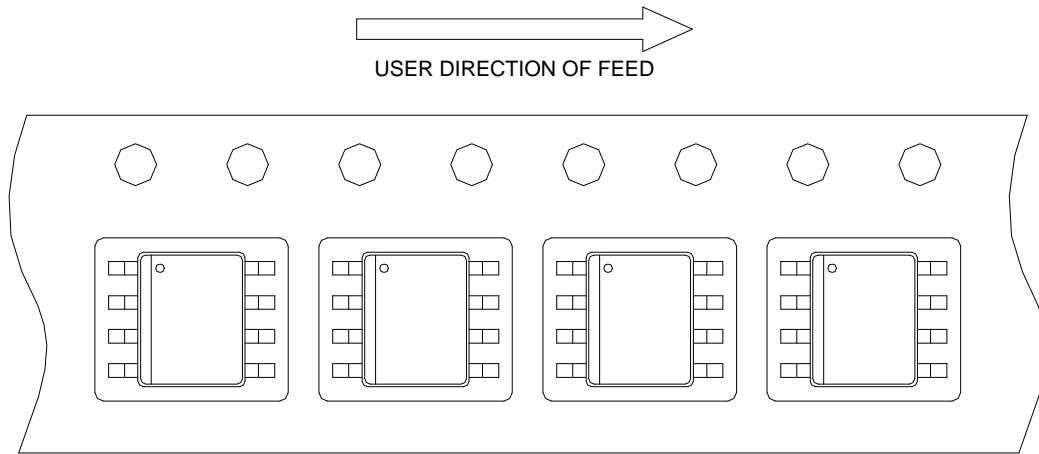

## Classification Profile

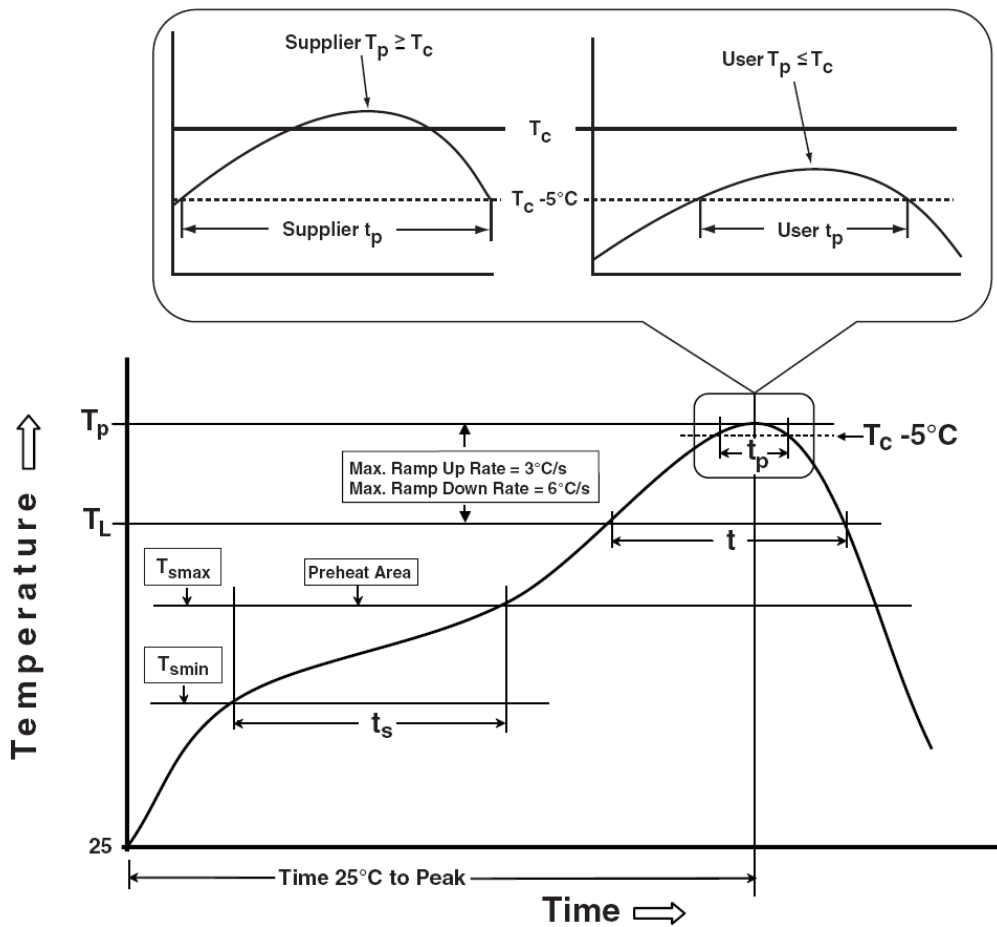

## Classification Reflow Profiles

Profile Feature	Sn-Pb Eutectic Assembly	Pb-Free Assembly
<b>Preheat &amp; Soak</b>		
Temperature min ( $T_{smin}$ )	100 °C	150 °C
Temperature max ( $T_{smax}$ )	150 °C	200 °C
Time ( $T_{smin}$ to $T_{smax}$ ) ( $t_s$ )	60-120 seconds	60-120 seconds
Average ramp-up rate ( $T_{smax}$ to $T_p$ )	3 °C/second max.	3°C/second max.
Liquidous temperature ( $T_L$ )	183 °C	217 °C
Time at liquidous ( $t_L$ )	60-150 seconds	60-150 seconds
Peak package body Temperature ( $T_p$ )*	See Classification Temp in table 1	See Classification Temp in table 2
Time ( $t_p$ )** within 5°C of the specified classification temperature ( $T_c$ )	20** seconds	30** seconds
Average ramp-down rate ( $T_p$ to $T_{smax}$ )	6 °C/second max.	6 °C/second max.
Time 25°C to peak temperature	6 minutes max.	8 minutes max.
* Tolerance for peak profile Temperature ( $T_p$ ) is defined as a supplier minimum and a user maximum. ** Tolerance for time at peak profile temperature ( $t_p$ ) is defined as a supplier minimum and a user maximum.		

Table 1. SnPb Eutectic Process – Classification Temperatures ( $T_c$ )

Package Thickness	Volume mm <sup>3</sup> <350	Volume mm <sup>3</sup> ≥350
<2.5 mm	235 °C	220 °C
≥2.5 mm	220 °C	220 °C

Table 2. Pb-free Process – Classification Temperatures ( $T_c$ )

Package Thickness	Volume mm <sup>3</sup> <350	Volume mm <sup>3</sup> 350-2000	Volume mm <sup>3</sup> >2000
<1.6 mm	260 °C	260 °C	260 °C
1.6 mm – 2.5 mm	260 °C	250 °C	245 °C
≥2.5 mm	250 °C	245 °C	245 °C

## Reliability Test Program

Test item	Method	Description
SOLDERABILITY	JESD-22, B102	5 Sec, 245°C
HOLT	JESD-22, A108	1000 Hrs, Bias @ 125°C
PCT	JESD-22, A102	168 Hrs, 100%RH, 2atm, 121°C
TCT	JESD-22, A104	500 Cycles, -65°C~150°C

## Customer Service

### Sinopower Semiconductor, Inc.

5F, No. 6, Dusing 1St Rd., Hsinchu Science Park,  
Hsinchu, 30078, Taiwan  
TEL: 886-3-5635818 Fax: 886-3-5642050